

# Ultra Short Feedback Cycles in Software Development

## From Quality Gates to Quality Doors

TechDebt 2020 — June 29<sup>th</sup>

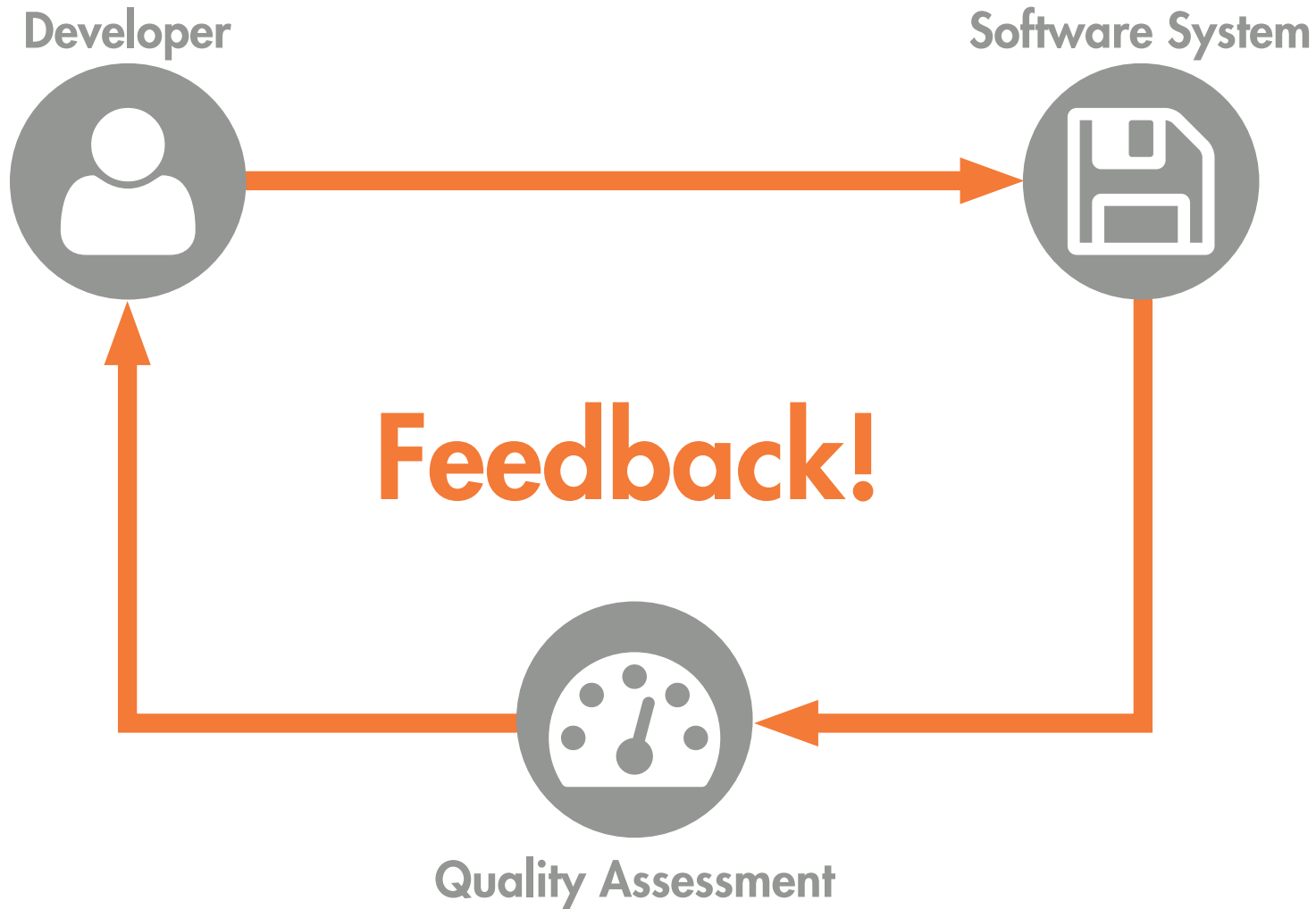



- i** Fast
- i** Specific
- i** Explicit

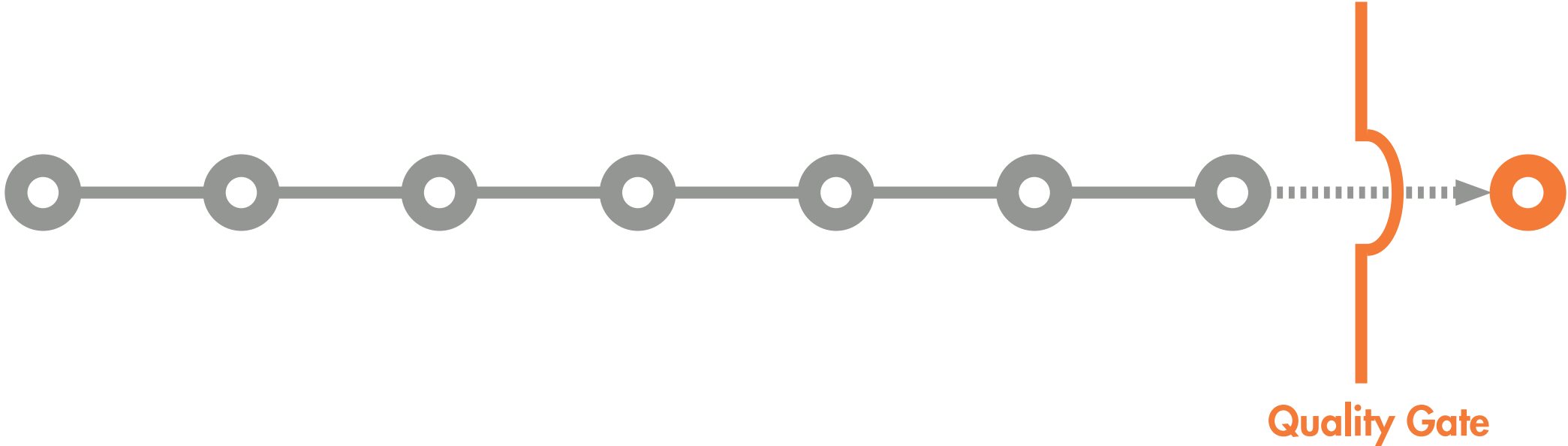



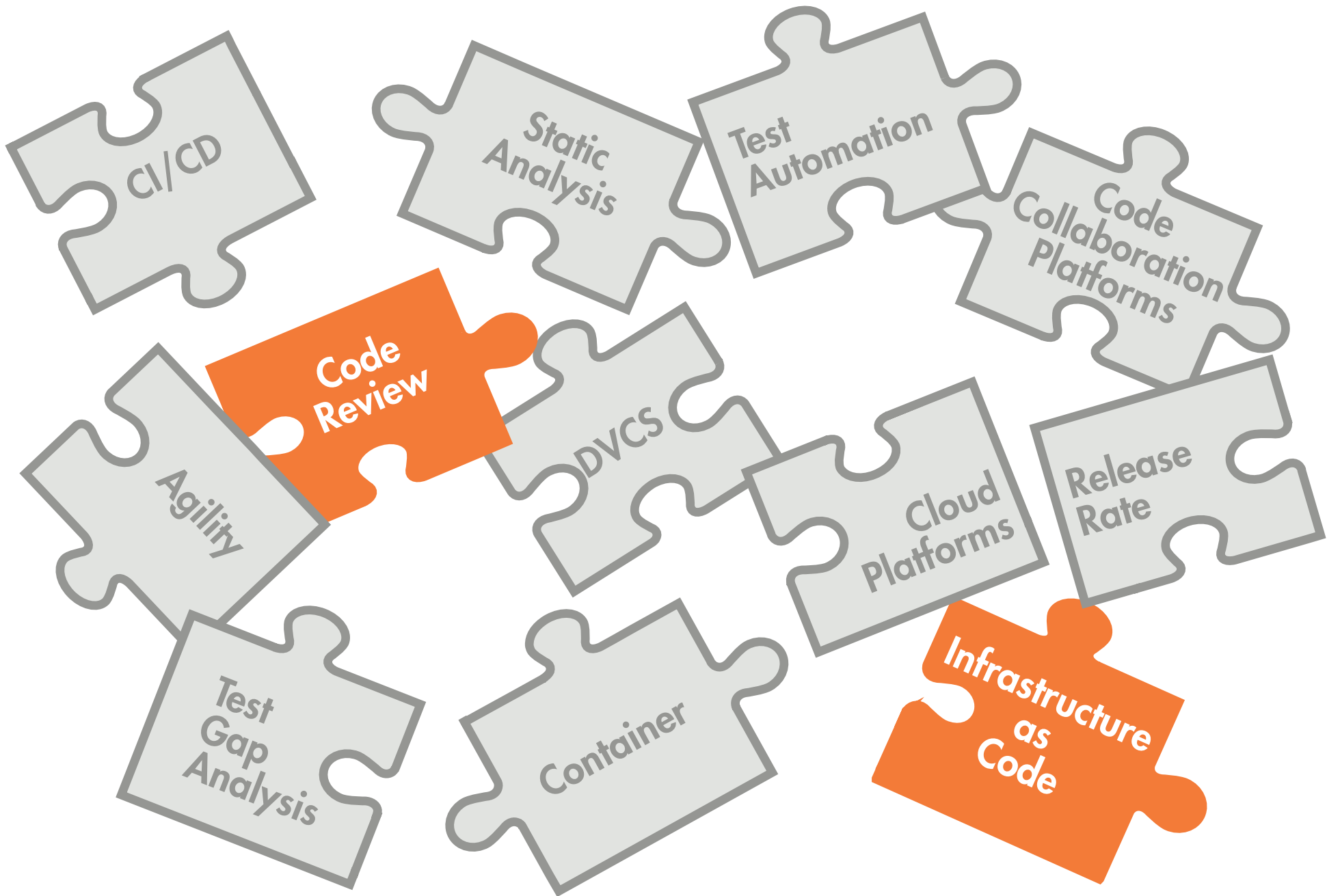

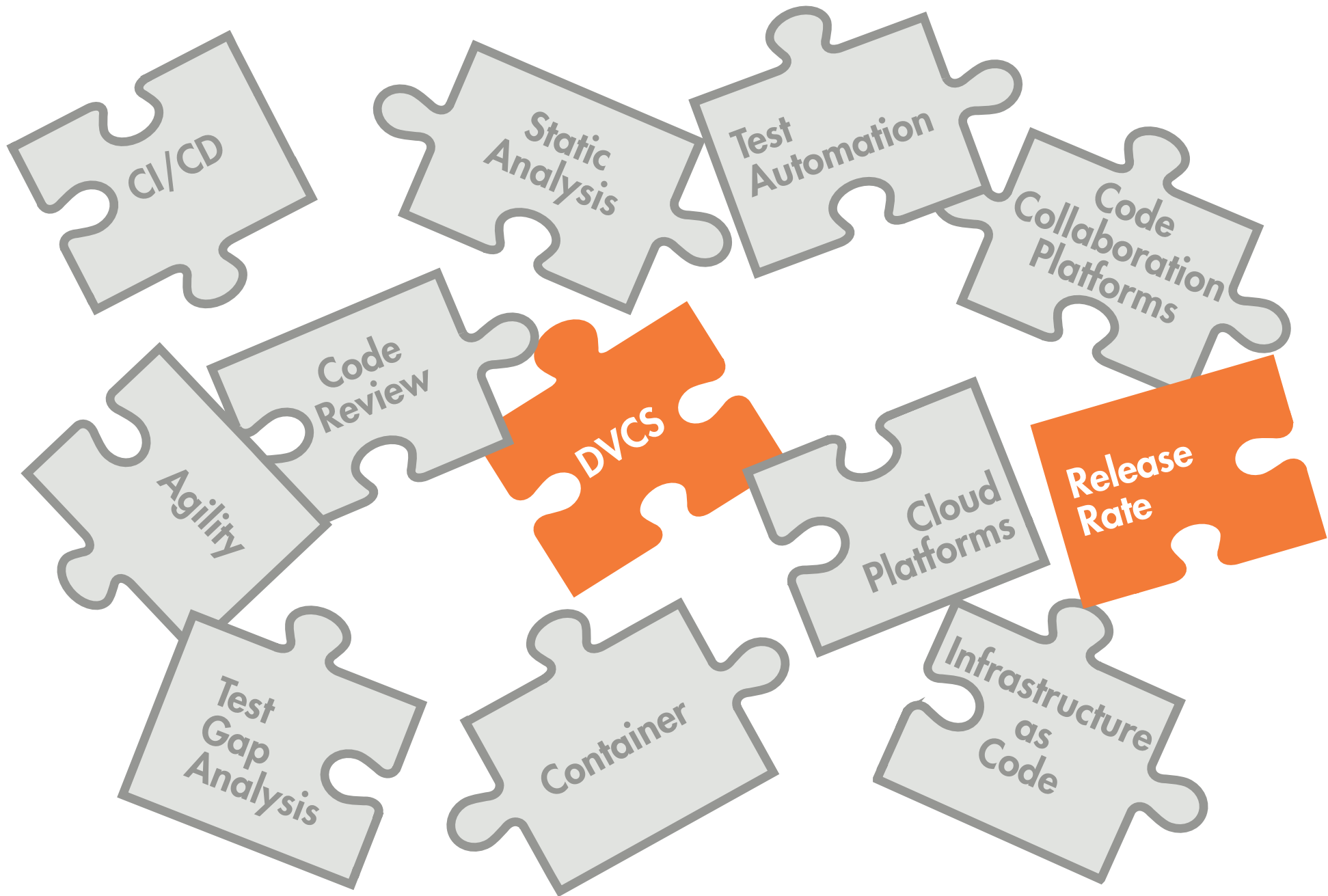

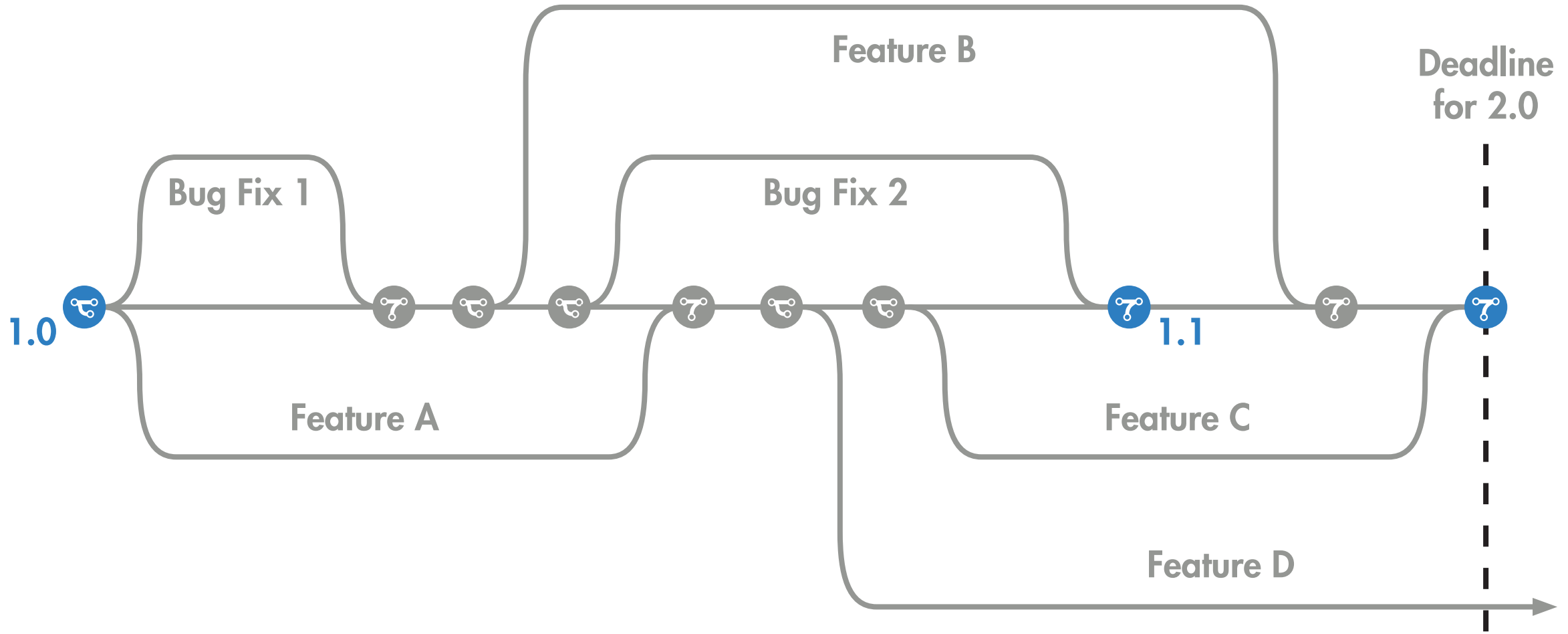
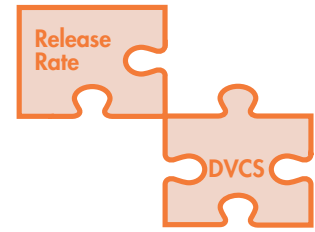



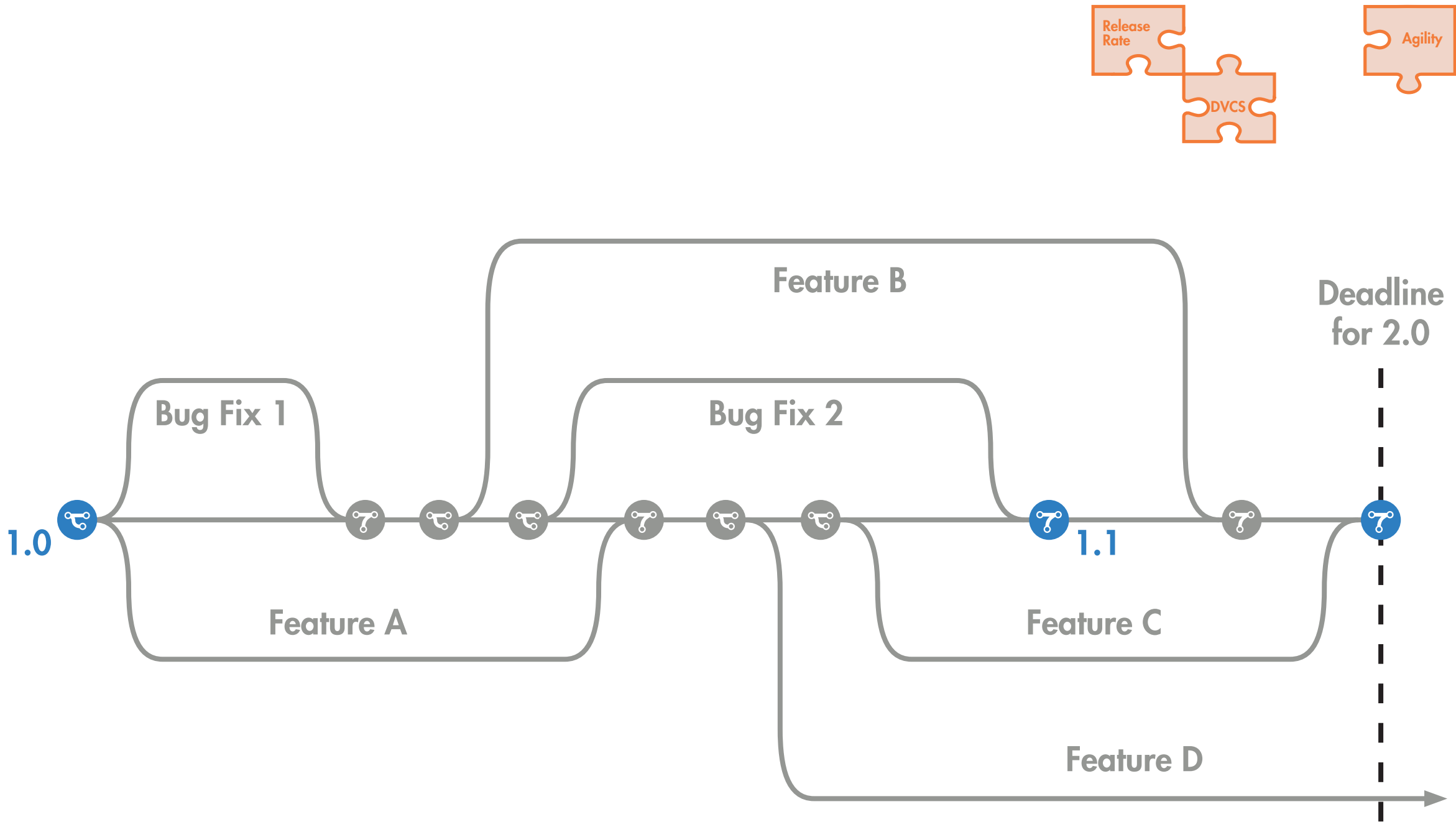

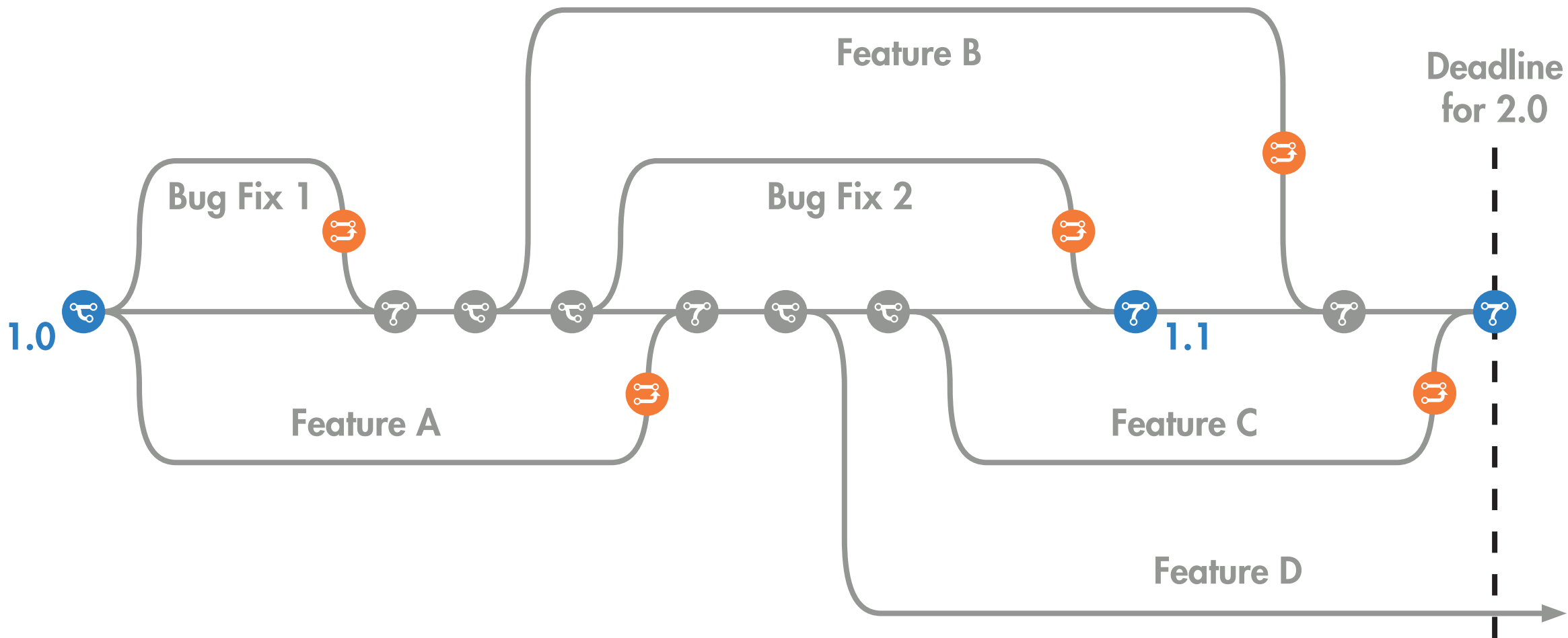
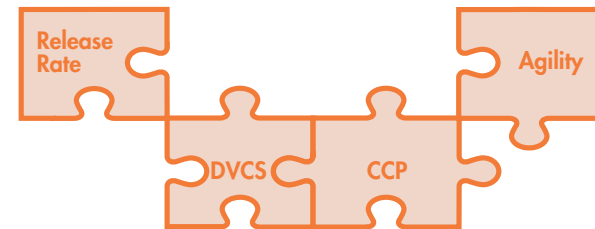

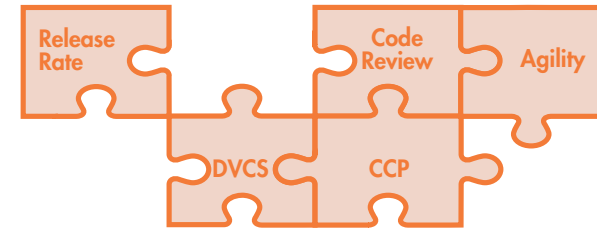





Discussion 1 Commits 2 Pipelines 2 Changes 1 Show all activity ▾ 1/1 thread resolved

 **Andreas Sewe** @sewe started a thread on an old version of the diff 4 months ago Resolved by Lars Heinemann 4 months ago [Toggle thread](#)

 **engine/org.conqat.engine.index/src/org/conqat/engine/index/repository/RepositoryContentUpdaterBase.java** 

```
293 293      List<BasicTokenElementInfo> tokenElements = tokenElementIndex.getValues(paths);
294 294      for (int i = 0; i < paths.size(); i++) {
295 295          String path = paths.get(i);
296 -         RepositoryChangeInfo changeInfo = changeSet.getChangeInfo(path);
297 -         ERepositoryChangeType changeType = patchChangeType(changeInfo,
           tokenElements.get(i));
298 -         if (changeType != null) {
299 -             result.add(new RepositoryChangeEntry(path,
           requiredNode.getRevision().getRevision(), changeType,
300 -             commit, changeInfo.getOriginPath(),
           changeInfo.getOriginCommit()));
301 -         }
296 +         BasicTokenElementInfo element = tokenElements.get(i);
297 +         addChangeEntry(requiredNode, result, changeSet, path, element);
```

 **Andreas Sewe** @sewe · 4 months ago Maintainer ✓ 😊 ⋮

I would re-order the message signature. ATM, it's hard to tell which parameter the change entry is added to. If you have `result` first, as in `result.add(...)` things become clearer.

Alternatively, let the extracted method return `Optional<RepositoryChangeEntry>` and do the `add` here.

```
computeChangeEntry(requiredNode, changeSet, path, element).ifPresent(result::add);
```

 **Lars Heinemann** @heinemann changed this line in version 2 of the diff 4 months ago

  Unresolve thread

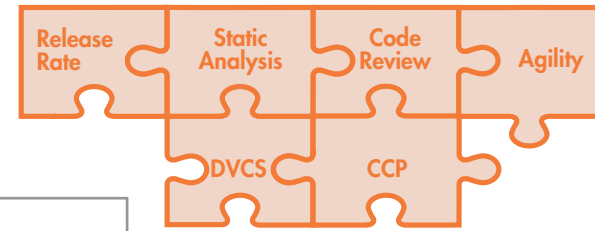

## PR #4

Open nkxater wants to merge 22 commits into master from firstBranch

Conversation 0 Commits 22 Checks 1 Files changed 3

Changes from all commits File filter... Jump to...

4 jabref/JabRefGUI.java

@@ -35,7 +35,7 @@

```
35
36 public class JabRefGUI {
37
38 - private static final Logger LOGGER = LoggerFactory.getLogger(JabRefGUI.class);
```

```
35
36 public class JabRefGUI {
37
38 + public static final Logger LOGGER = LoggerFactory.getLogger(JabRefGUI.class);
```

Check warning on line 38 in jabref/JabRefGUI.java  
 Teamscale App / Teamscale Findings  
jabref/JabRefGUI.java#L38  
Interface comment missing

2 jabref/logic/bibtex/BibEntryWriter.java

@@ -163,7 +163,7 @@ private void writeField(BibEntry entry, Writer out, String name, int indentation

```
163 try {
164     out.write(fieldFormatter.format(field.get(), name));
165     out.write(',') + OS.NEWLINE);
166 - } catch (InvalidFieldValueException ex) {
167     throw new IOException("Error in field '" + name + "': " + ex.getMessage(), ex);
168 }
```

```
163 try {
164     out.write(fieldFormatter.format(field.get(), name));
165     out.write(',') + OS.NEWLINE);
166 + } catch (Exception ex) {
167     throw new IOException("Error in field '" + name + "': " + ex.getMessage(), ex);
168 }
```

Check failure on line 168 in jabref/logic/bibtex/BibEntryWriter.java  
 Teamscale App / Teamscale Findings  
jabref/logic/bibtex/BibEntryWriter.java#L166-L168  
Catch clause catches generic exception `Exception`

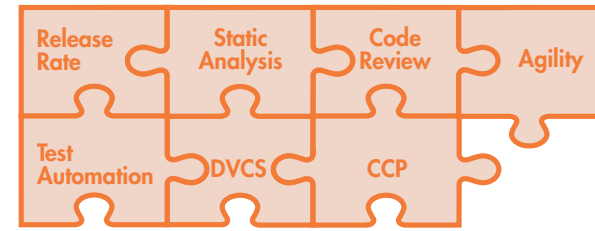

## Cr/20002 new report template

Edited 9 hours ago by build



**Request to merge** cr/20002\_new\_report\_t... **into** teamscale/v5.4.x  
The source branch is 31 commits behind the target branch

Open in Web IDE

Check out branch



**Pipeline #89447 failed for 040f1ce9 on cr/20002\_new\_report\_t...**



Test summary contained 5 failed test results out of 4318 total tests

Expand



**Merge**



Delete source branch



Squash commits [?](#)



**8 commits** and **1 merge commit** will be added to teamscale/v5.4.x. [Modify merge commit](#)

You can merge this merge request manually using the [command line](#)

# Cr/20002 new report template

Edited 9 hours ago by build



**Request to merge** cr/20002\_new\_report\_t... **into** teamscale/v5.4.x

The source branch is 31 commits behind the target branch

Open in Web IDE

Check out branch



**Pipeline #89447 failed for 040f1ce9 on cr/20002\_new\_report\_t...**



Test summary contained 5 failed test results out of 4318 total tests



integration-tests found no changed test results out of 2040 total tests



system-tests found no changed test results out of 193 total tests



ui-tests found 5 failed test results out of 29 total tests



**New** IssueDetailTest.testCompareLinks



**New** deleteArchitectureUpload()



**New** ProjectActivityChartTest.testProjectActivityChartPage



**New** testDuplicateSlides()



**New** createReportWithArchitectureAndBaselineAndHead()



unit-tests found no changed test results out of 1919 total tests



js-tests found no changed test results out of 137 total tests



- ui-tests
- dotnet-tests
- integration-tests
- js-tests
- system-tests
- ui-tests-common-lang

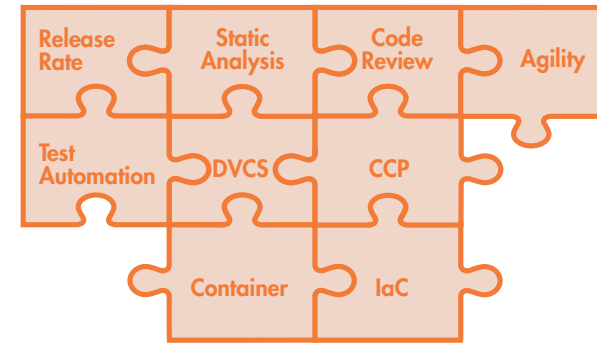

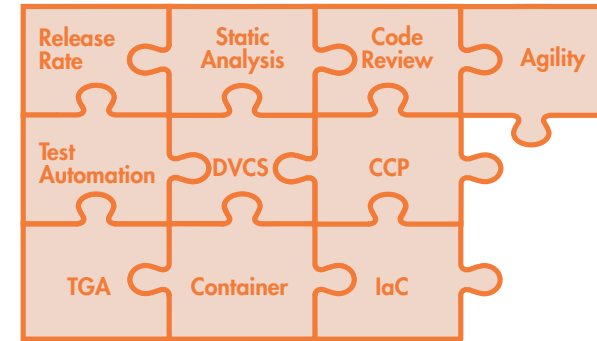

**Done** Issue **TS-14733 - Remove Dataflow blocks**

Last update: Aug 24 2018 09:32

**Creator:**  (on Apr 06 2018 19:44)

**Assignee:** 

Project	Type	Priority	Resolution	Fix Version
TS	Maintenance	Normal	Green	Teamscale 4.5
Component	Labels	Affected Version	Customer	Customer Issue
Backend	Performance			
Epic Name	Freshdesk URL	Merge Request		
		<a href="https://git.cqse.eu/cqse/teamscale/3621">https://git.cqse.eu/cqse/teamscale/3621</a>		

Aug 15 2018 12:37–Now | Test Gap: 22%

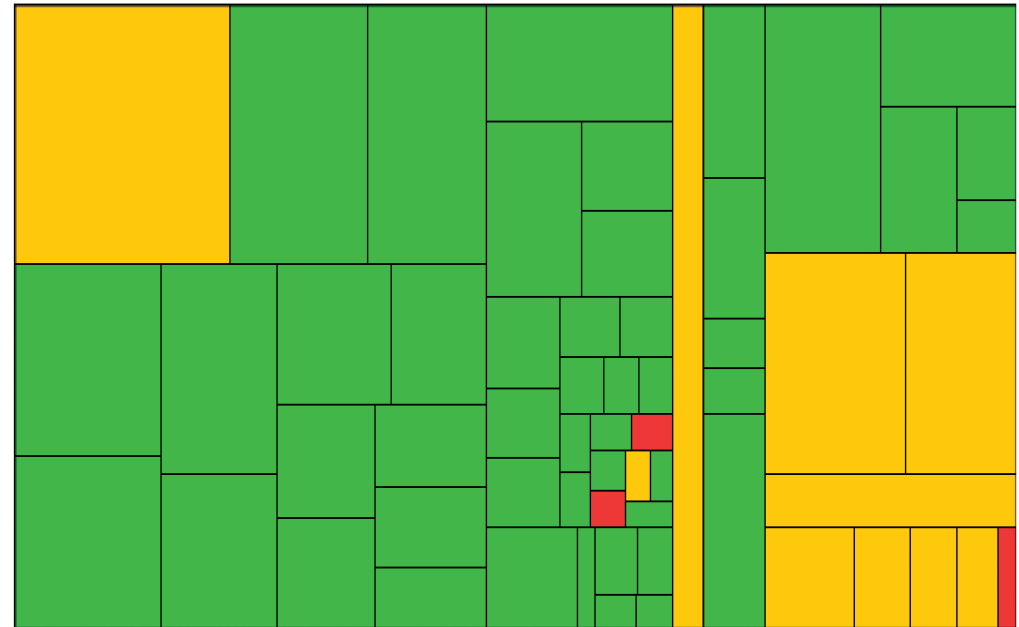

- ✓ Fast
- ✓ Specific
- ✓ Explicit

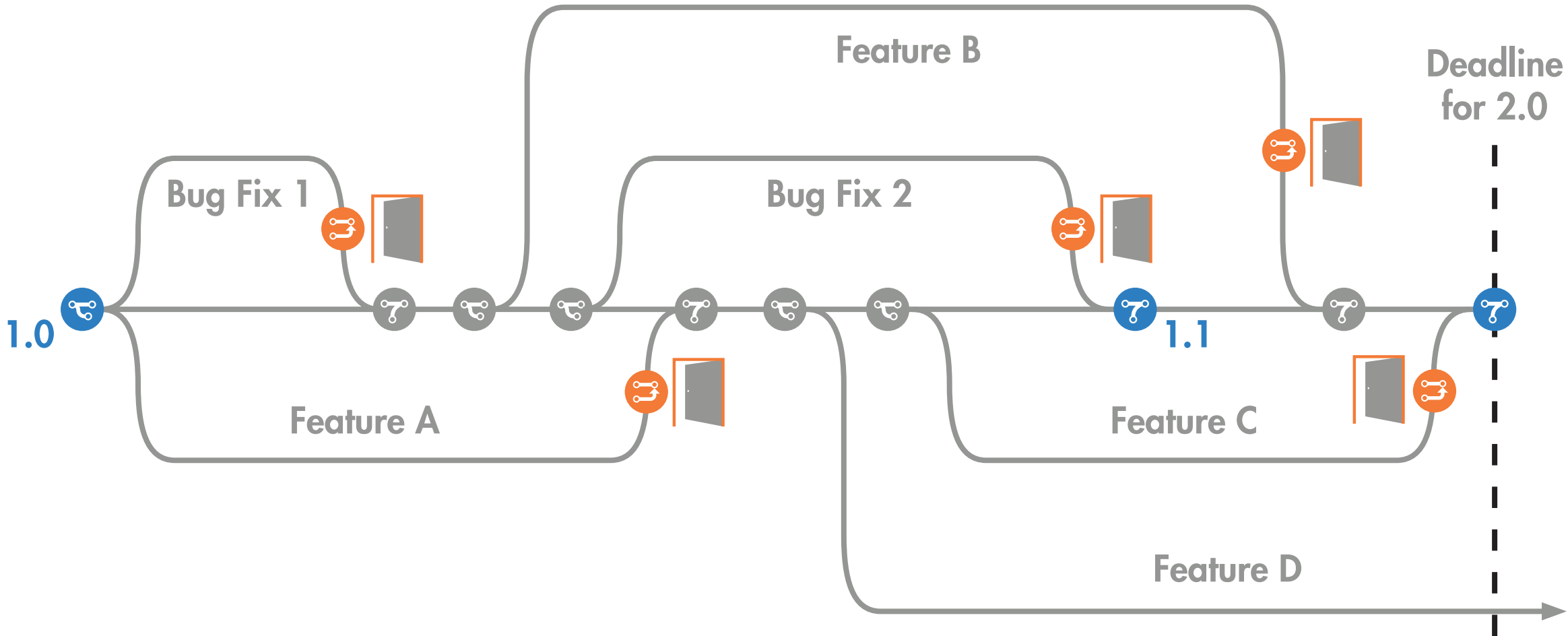
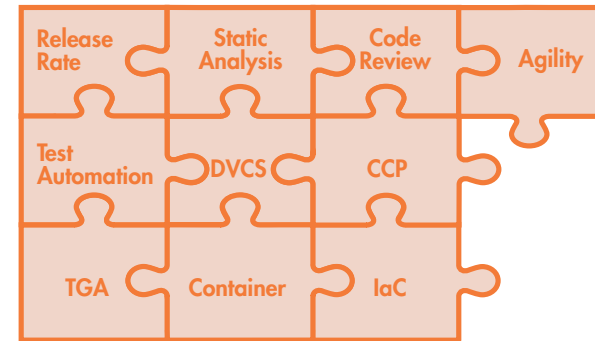



? Fast

✓ Specific

✓ Explicit

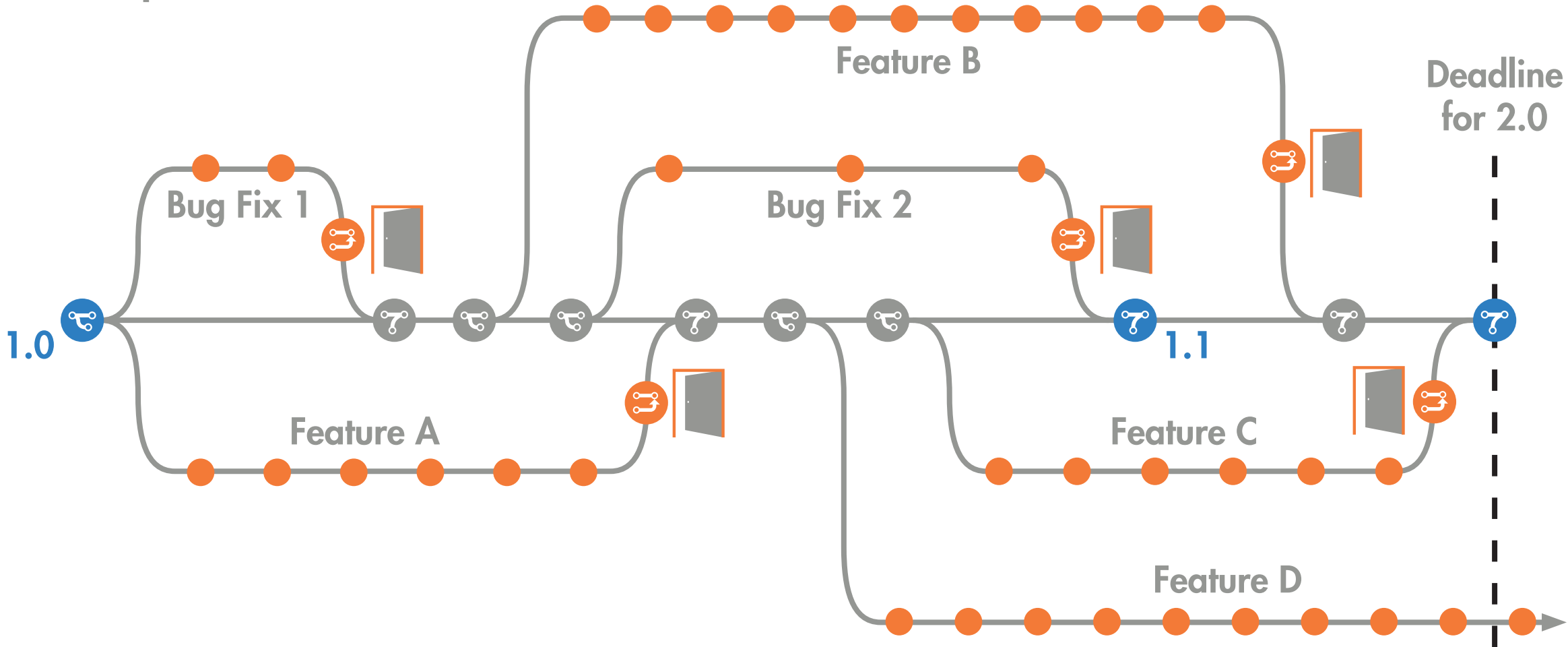
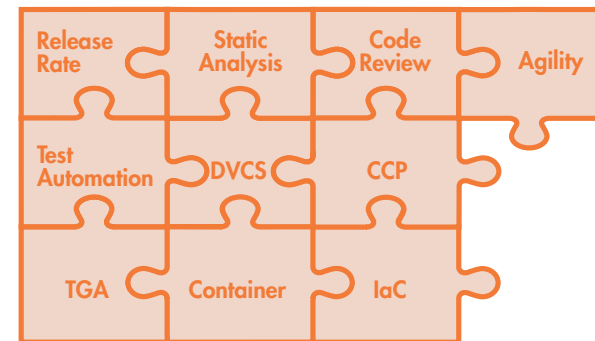

- ✓ Fast
- ✓ Specific
- ✓ Explicit

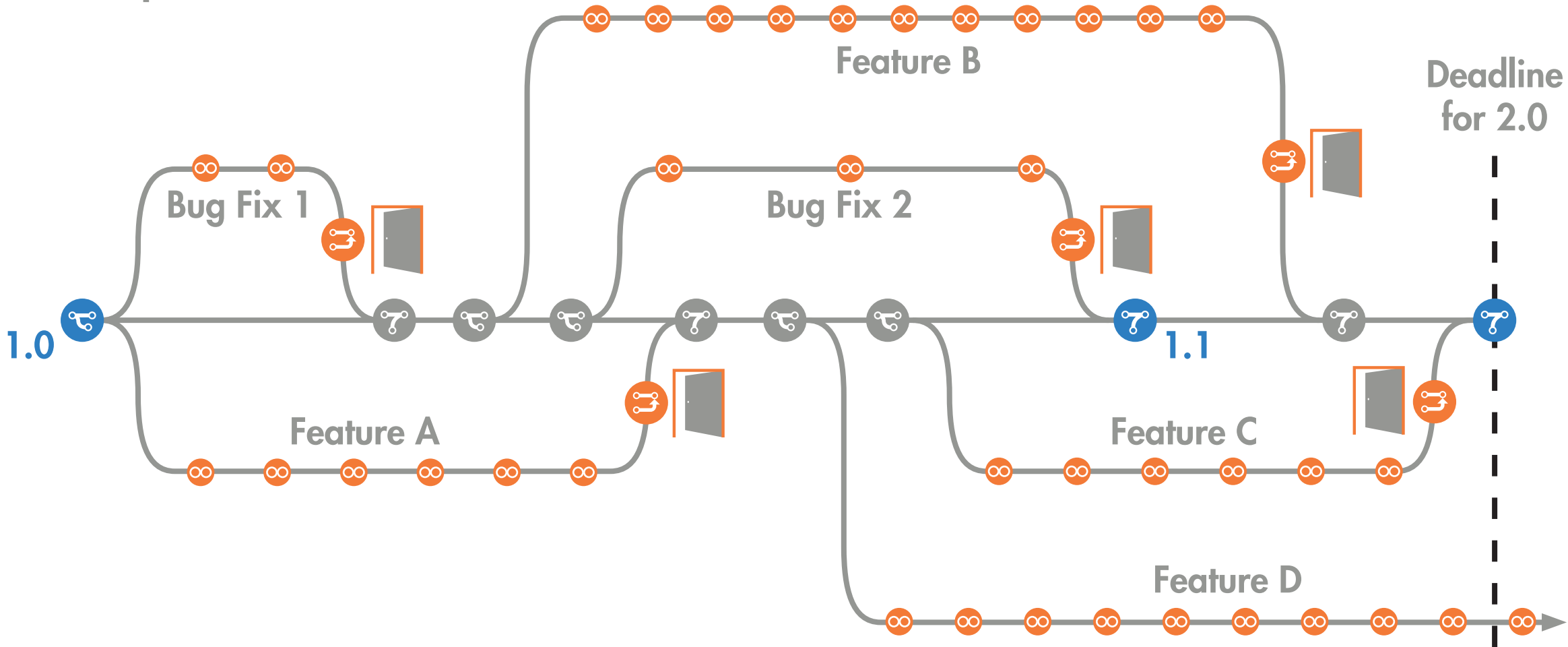
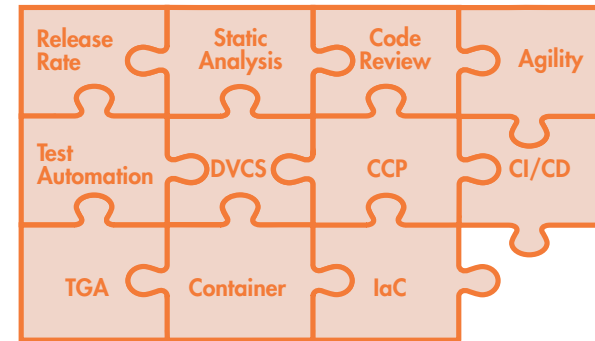

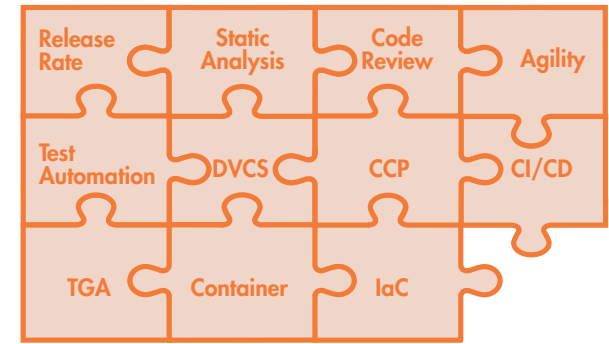
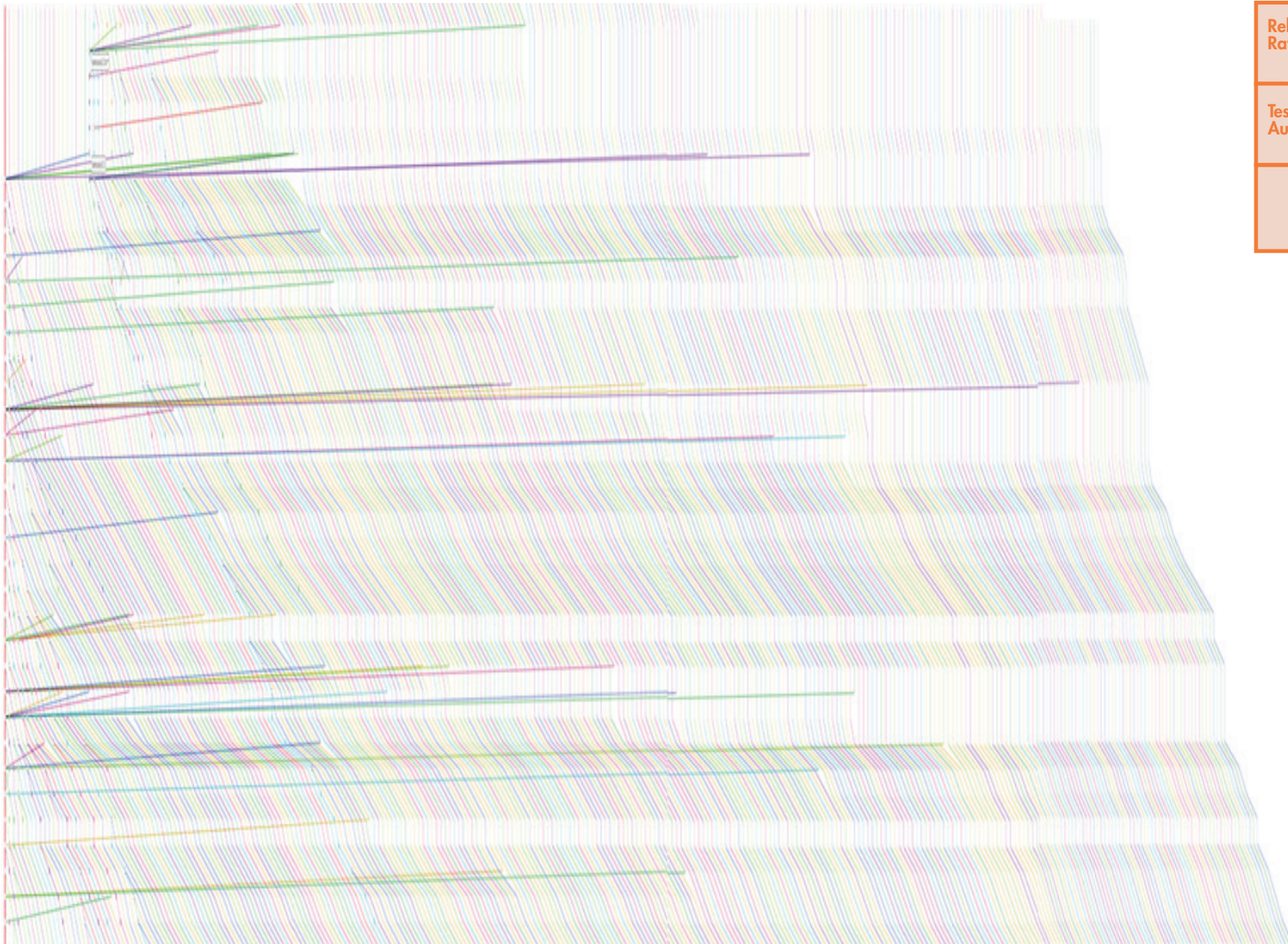

# LOC	968,492
# Developer	20
# Open Merge Requests	178
# Automated Tests	8,011
Test Execution Time	6,098 s

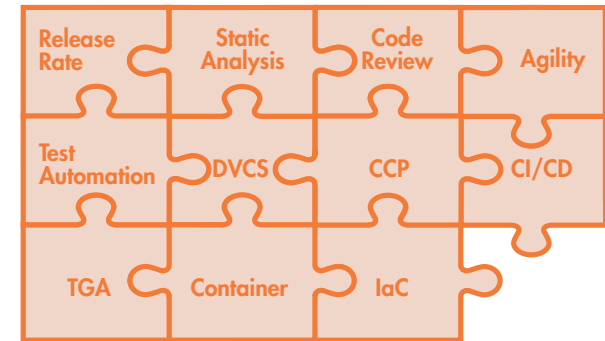

# Tests

Execution Time

317

UI  
Tests

3,316 s

191

System Tests

801 s

2,038

Integration Tests

1,665 s

5,465

Unit Tests (Java, JS, C#, ...)

316 s

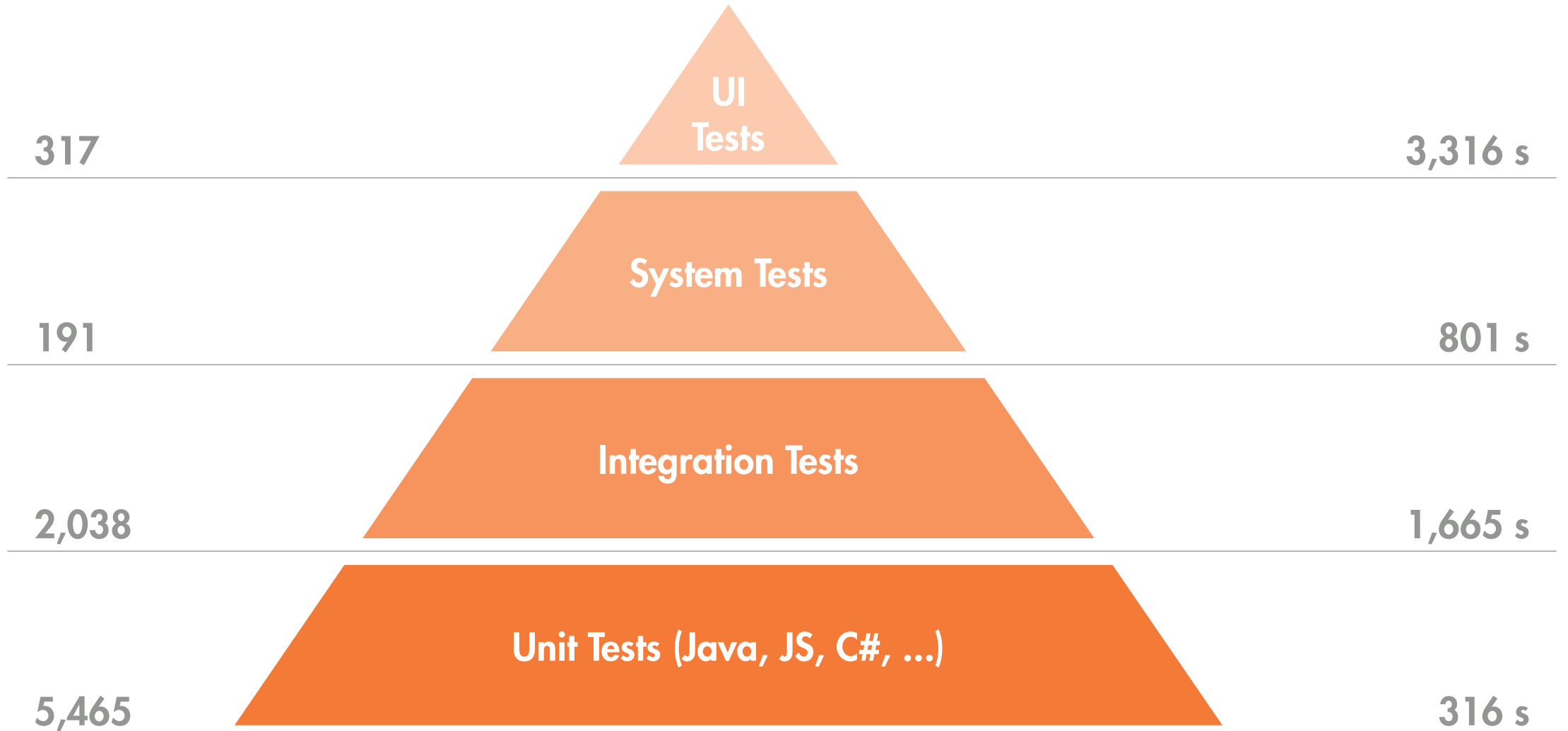

# LOC 968,492

---

# Developer 20

---

# Open Merge Requests 178

---

# Automated Tests 8,011

---

Test Execution Time 6,098 s

---

# Commits/h 2.1

---

# Build Jobs/h 25

---

# Build Server 7

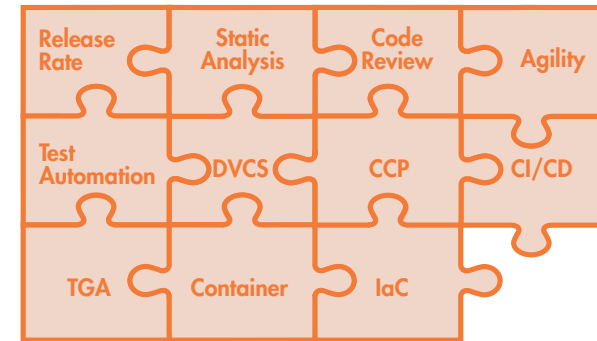

## Test Impact Analysis (TIA)

# LOC 968,492

---

# Developer 20

---

# Open Merge Requests 178

---

# Automated Tests 8,011

---

Test Execution Time 6,098 s **Max**

---

# Commits/h 2.1 **26**

---

# Build Jobs/h 25 **257**

---

# Build Server 7 **50**

---

Cost/Month 500 €

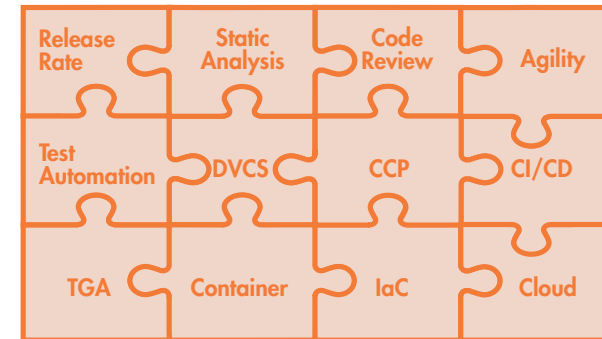

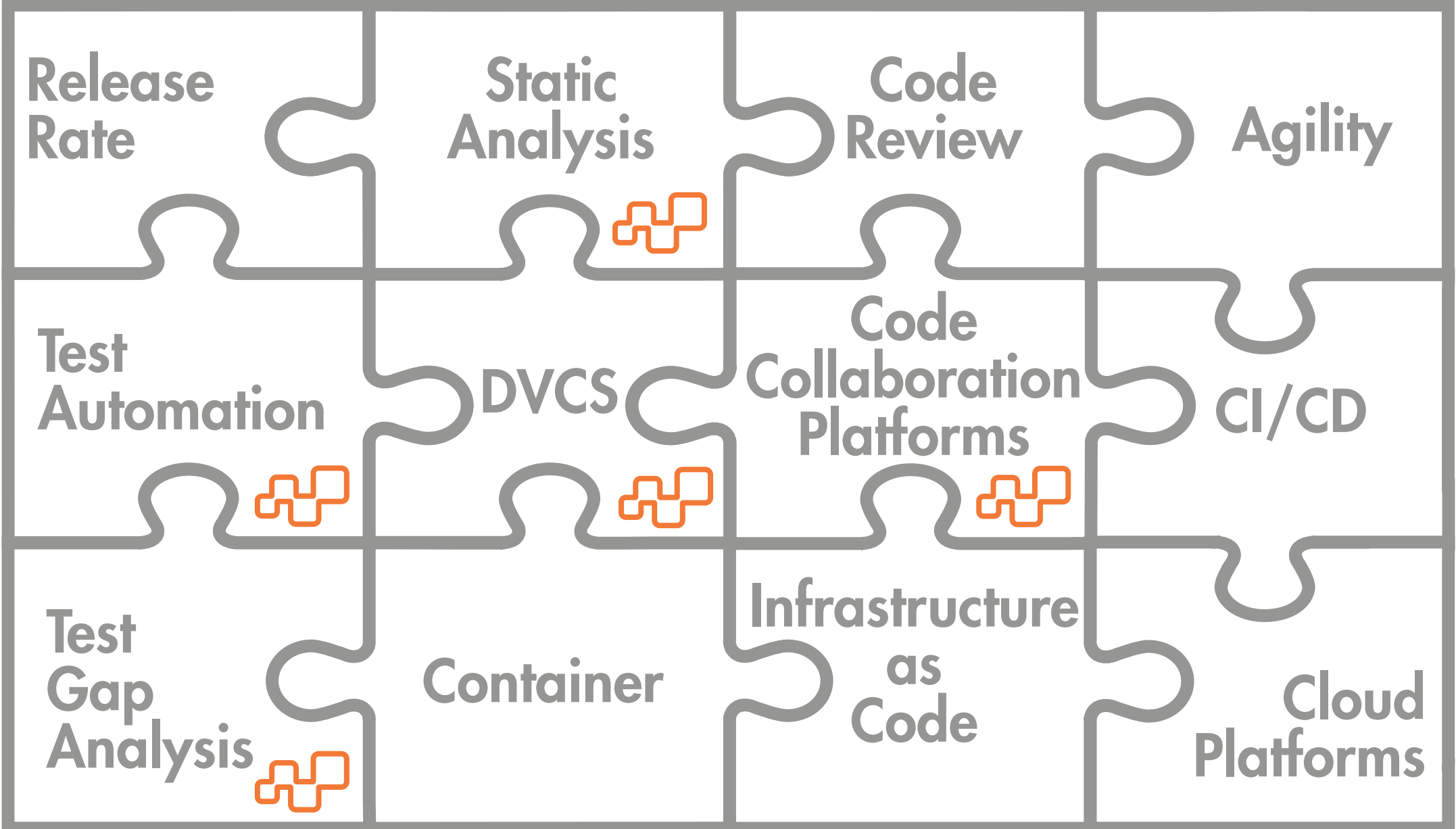

Release Rate

Static Analysis

Code Review

Agility

Test Automation

DVCS

Code Collaboration Platforms

CI/CD

Test Gap Analysis

Container

Infrastructure as Code

Cloud Platforms



You?



CQSE



Dr. Florian Deißböck  
deissenboeck@cqse.eu  
+49 179 7857188  
@deissenboeck



<https://cqse.eu>  
@cqse



<https://cqse.eu/blog>



<https://teamscale.com>  
@teamscale