

# Qualitäts-Türchen statt Quality-Gates

---

SAEC Days · 29. Juni 2022



TECHNISCHE  
UNIVERSITÄT  
DARMSTADT



CQSE

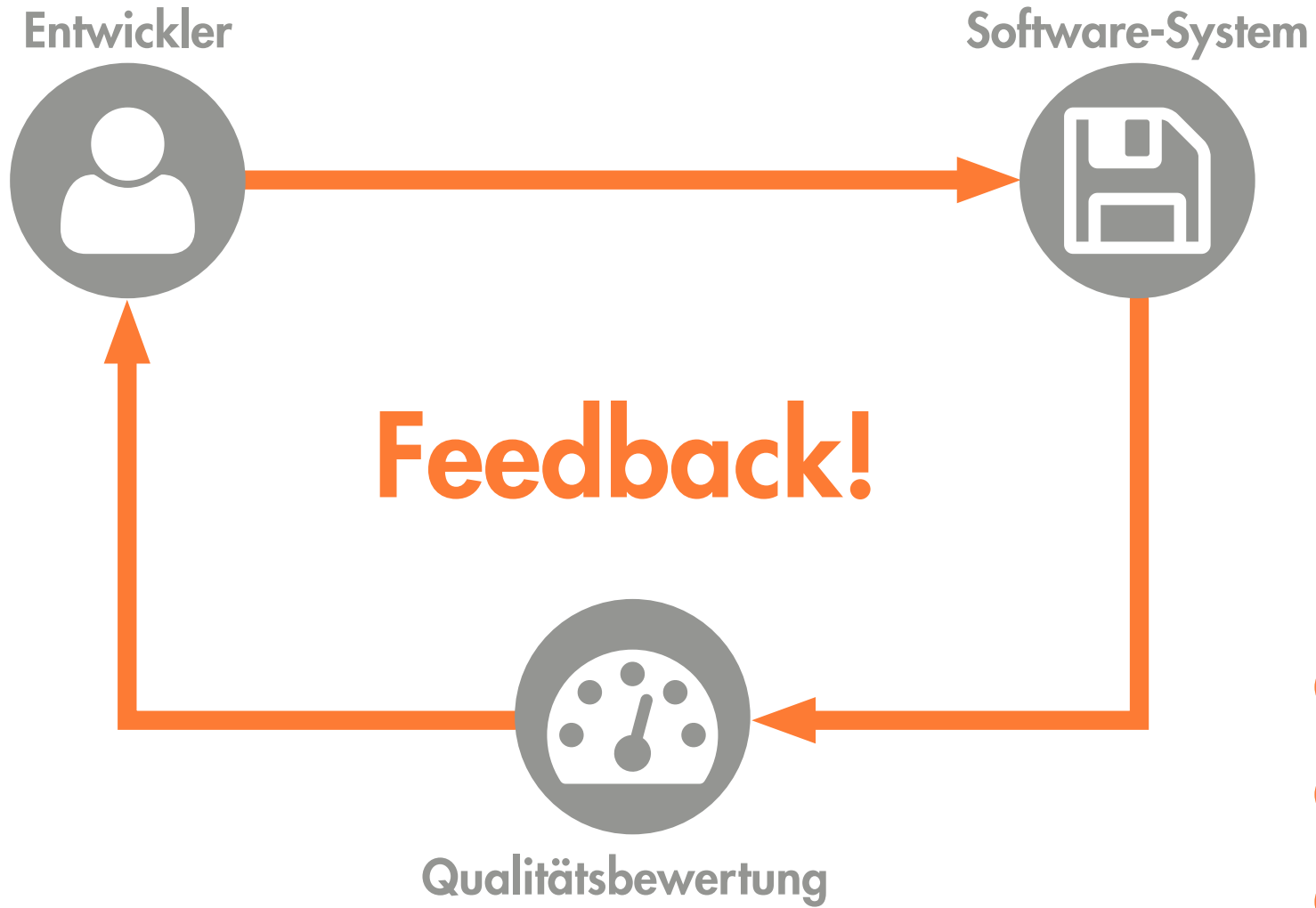

- i** Schnell
- i** Spezifisch
- i** Explizit

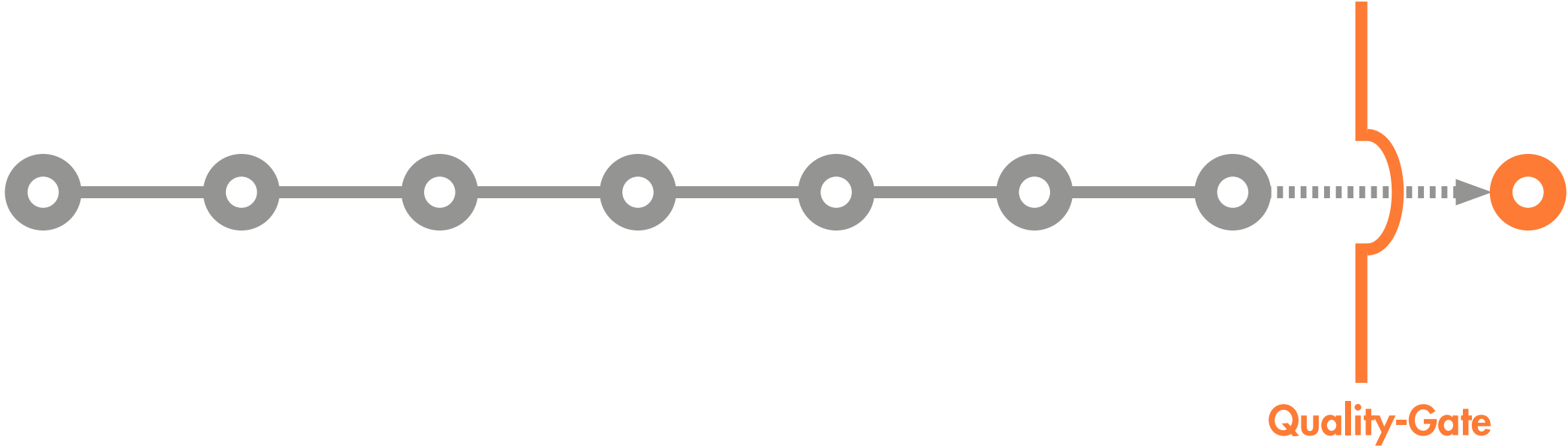

平成六年七月吉日建之

平成二十五年二月吉日建之

㈱誠和グループ

永田淳世

奥山大輔 川口大介  
坂本亮雄 二戸貴之

兵庫県安芸郡山崎町山崎一三六  
しずのや食料品店

本店 杉谷收治郎  
東店 杉谷昭十九



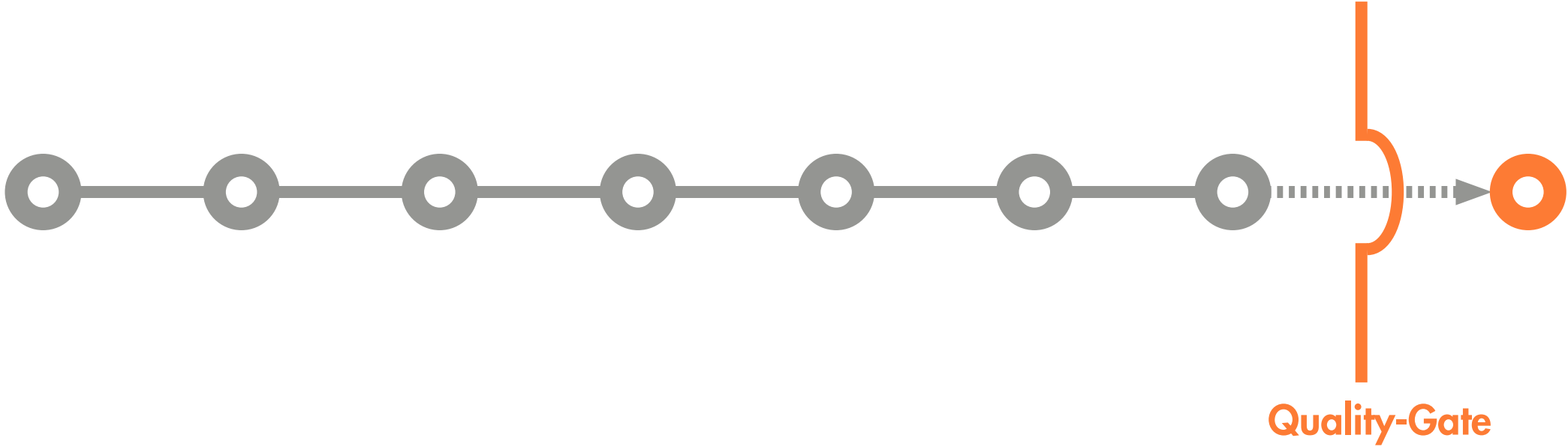

CI/CD

Statische  
Analyse

Test-Auto-  
matisierung

Code  
Collaboration  
Platforms

Code  
Review

DVCS

Cloud-  
Plattformen

Release-  
Frequenz

Agilität

Test-  
Gap-  
Analyse

Container

Infrastructure  
as  
Code

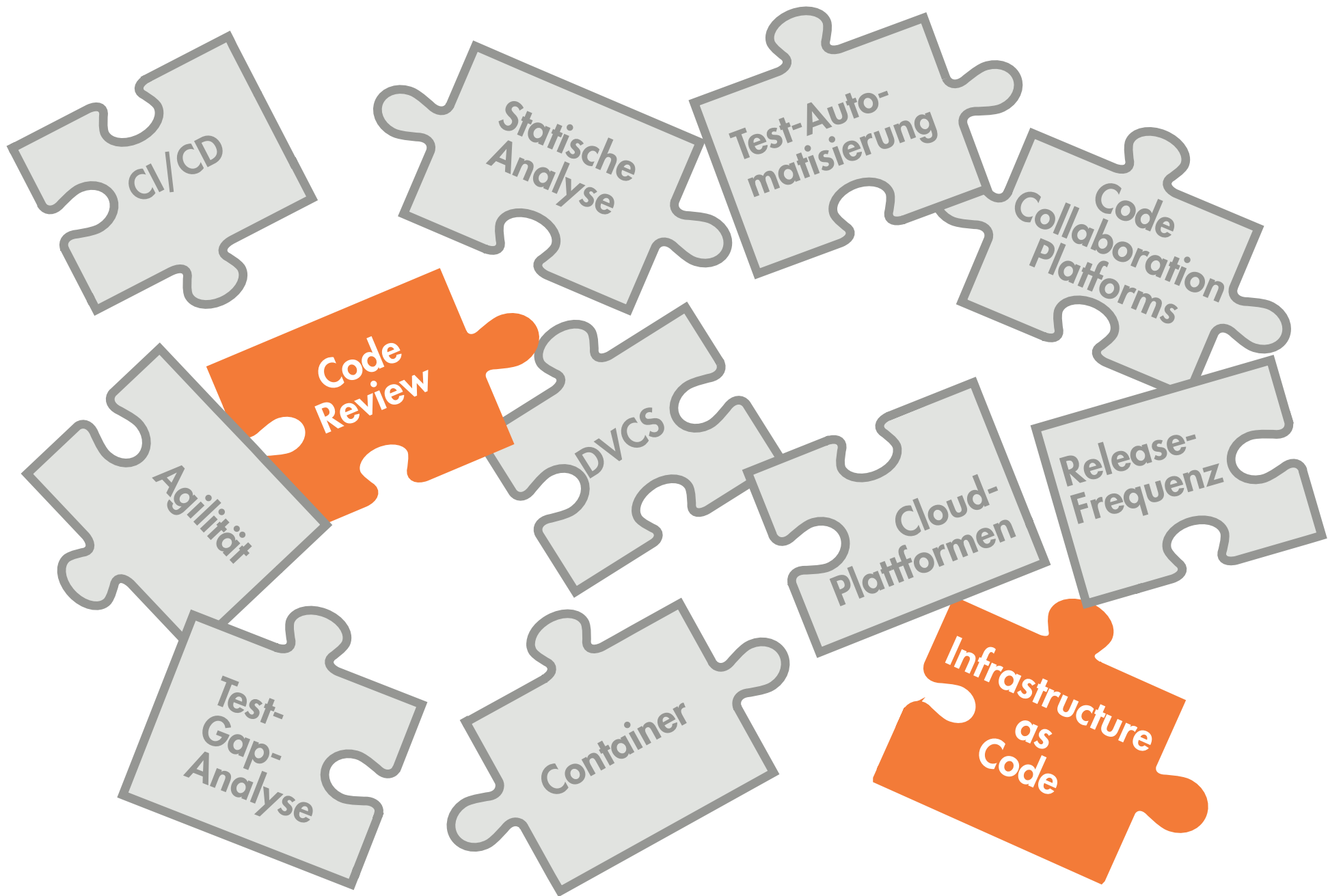

CI/CD

Statische  
Analyse

Test-Auto-  
matisierung

Code  
Collaboration  
Platforms

Code  
Review

DVCS

Agilität

Cloud-  
Plattformen

Release-  
Frequenz

Test-  
Gap-  
Analyse

Container

Infrastructure  
as  
Code



CI/CD

Statische  
Analyse

Test-Auto-  
matisierung

Code  
Collaboration  
Platforms

Code  
Review

DVCS

Cloud-  
Plattformen

Release-  
Frequenz

Agilität

Test-  
Gap-  
Analyse

Container

Infrastructure  
as  
Code

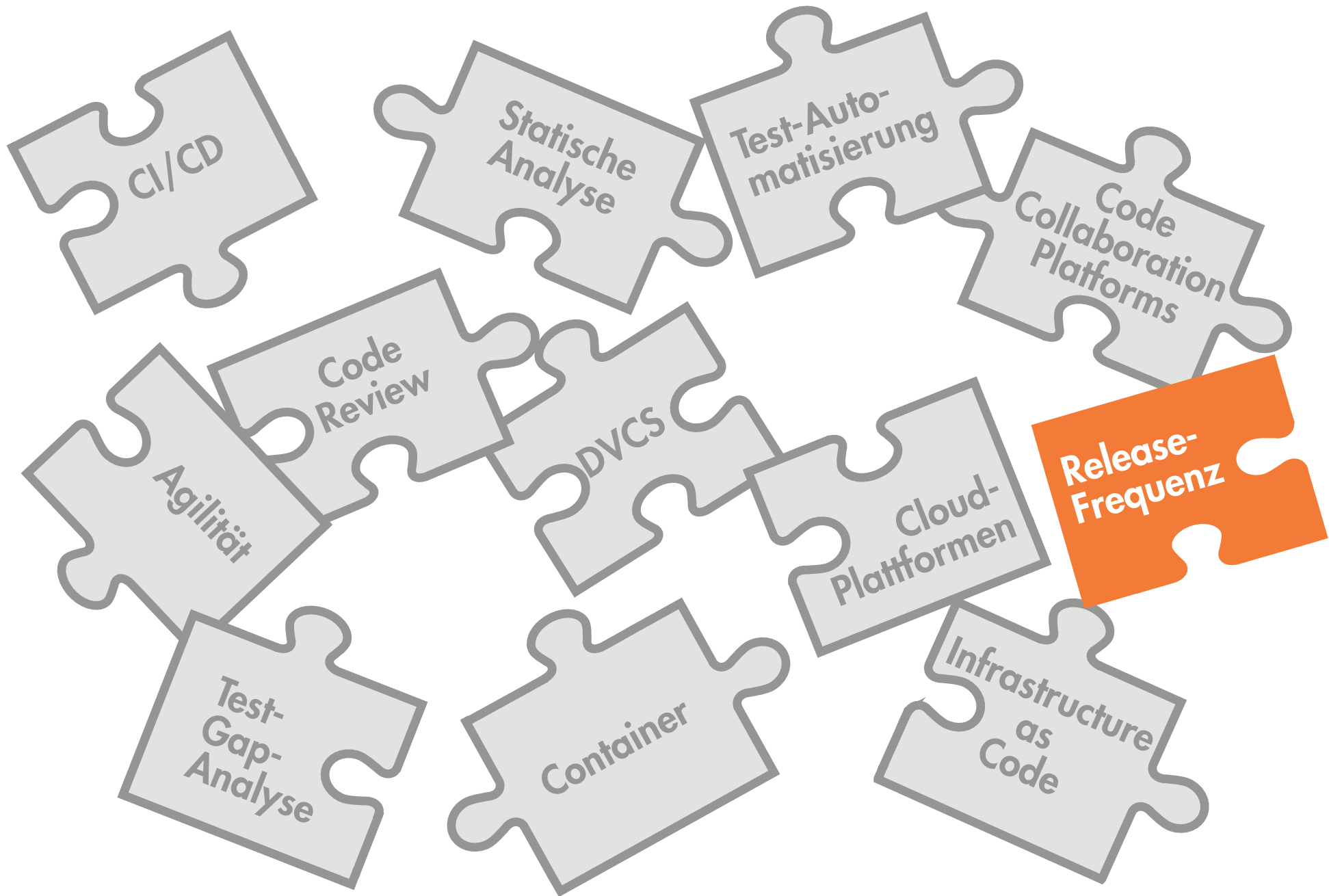

CI/CD

Statische  
Analyse

Test-Auto-  
matisierung

Code  
Collaboration  
Platforms

Code  
Review

DVCS

Cloud-  
Plattformen

Release-  
Frequenz

Agilität

Container

Test-  
Gap-  
Analyse

Infrastructure  
as  
Code

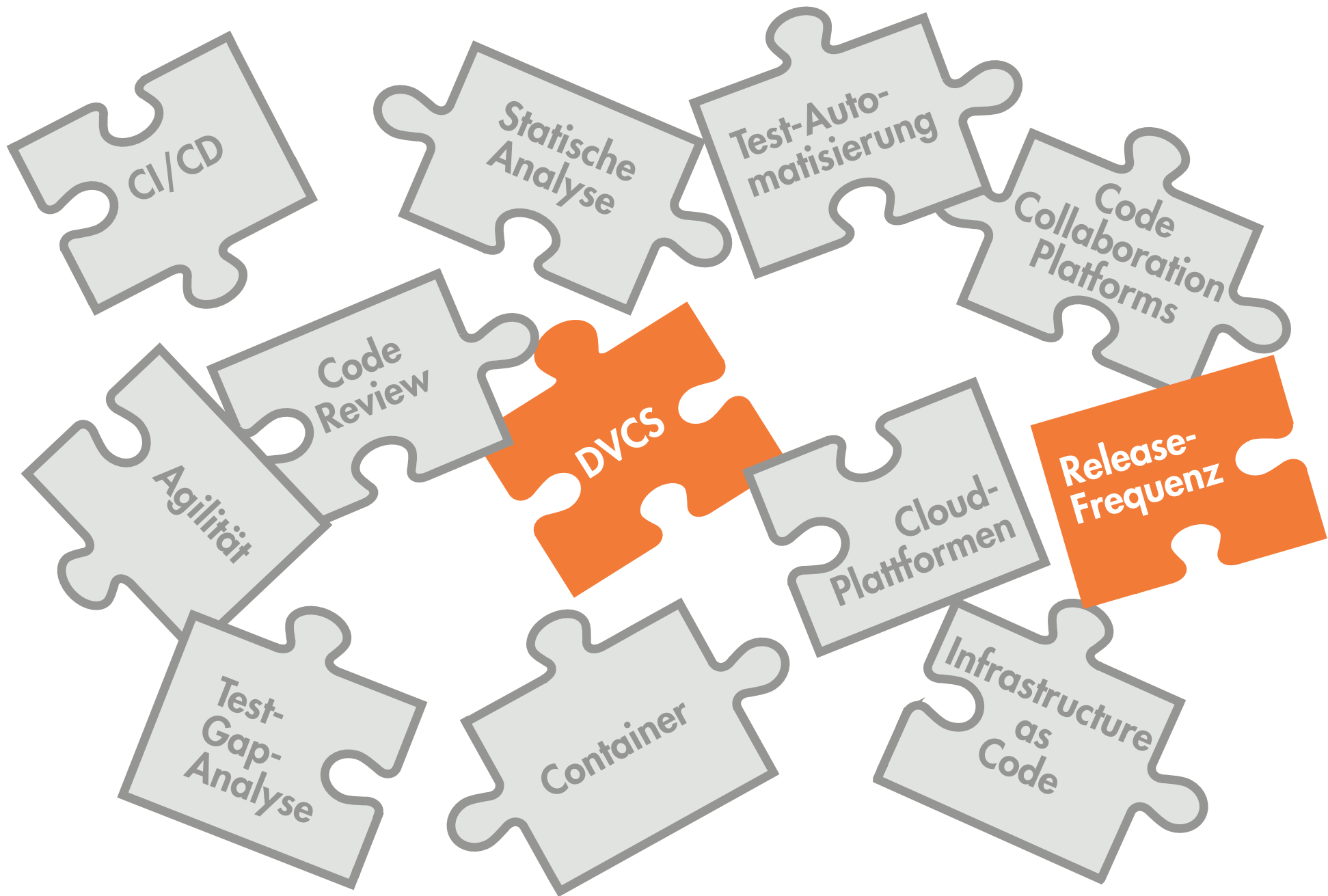

CI/CD

Statische Analyse

Test-Automatisierung

Code Collaboration Platforms

Code Review

DVCS

Agilität

Cloud-Plattformen

Release-Frequenz

Test-Gap-Analyse

Container

Infrastructure as Code

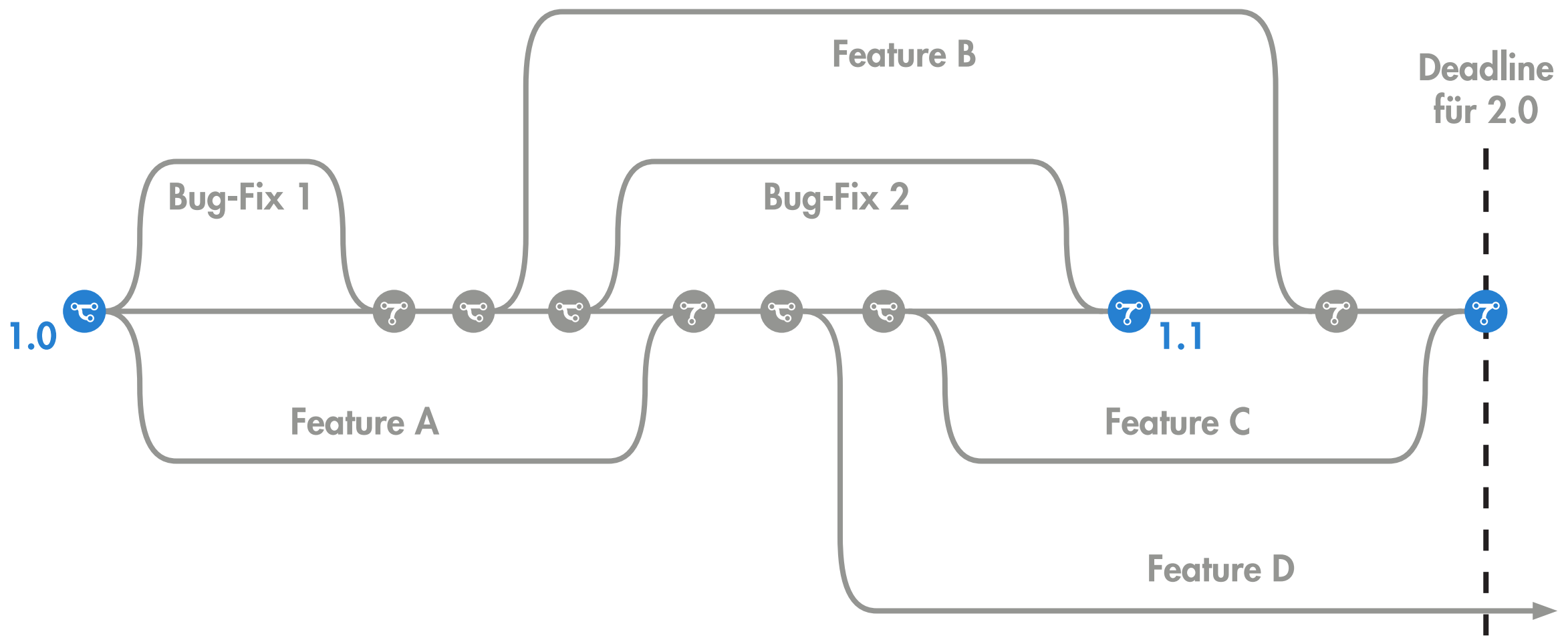
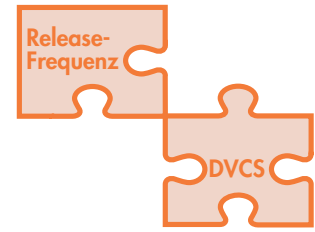

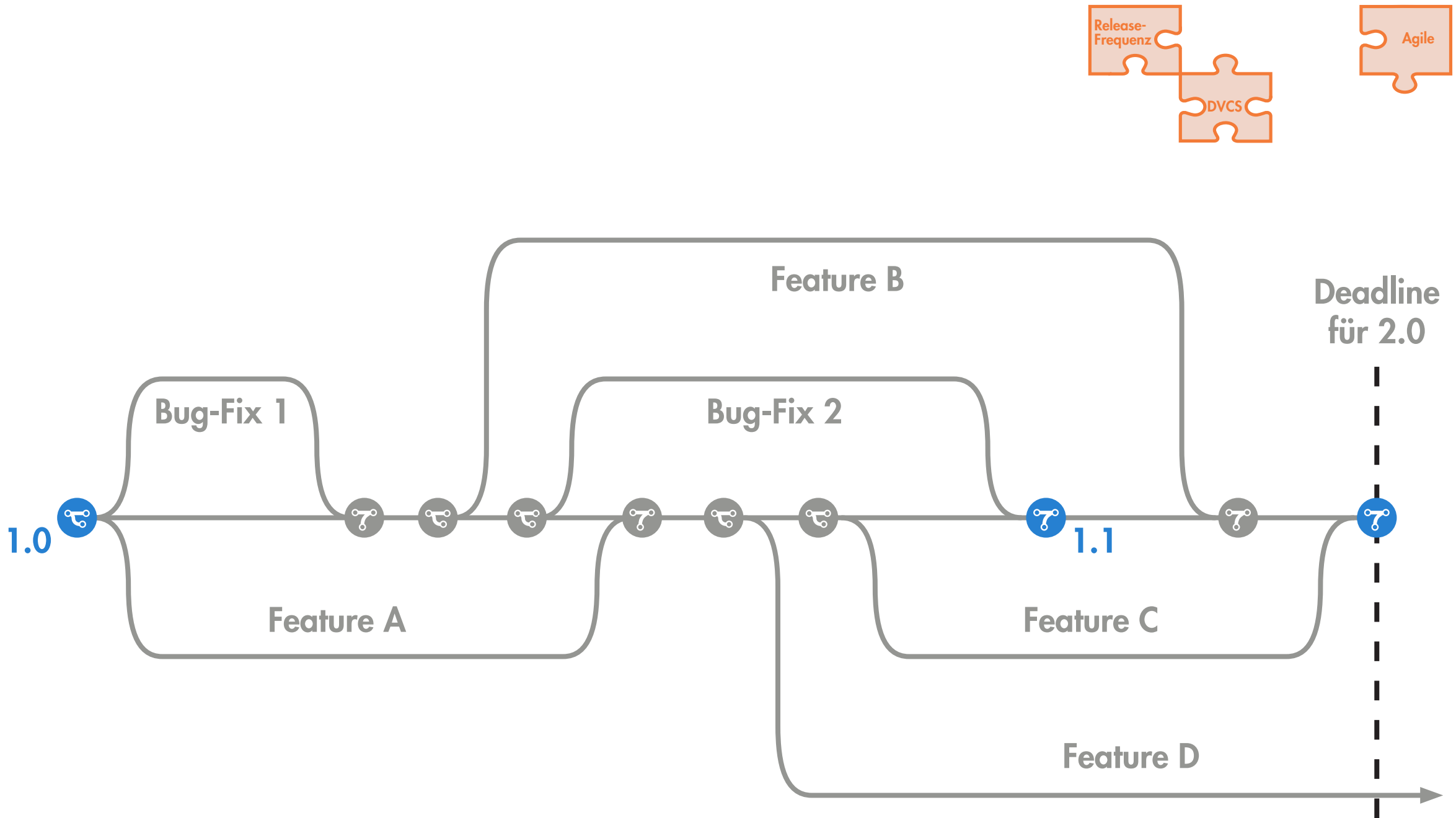

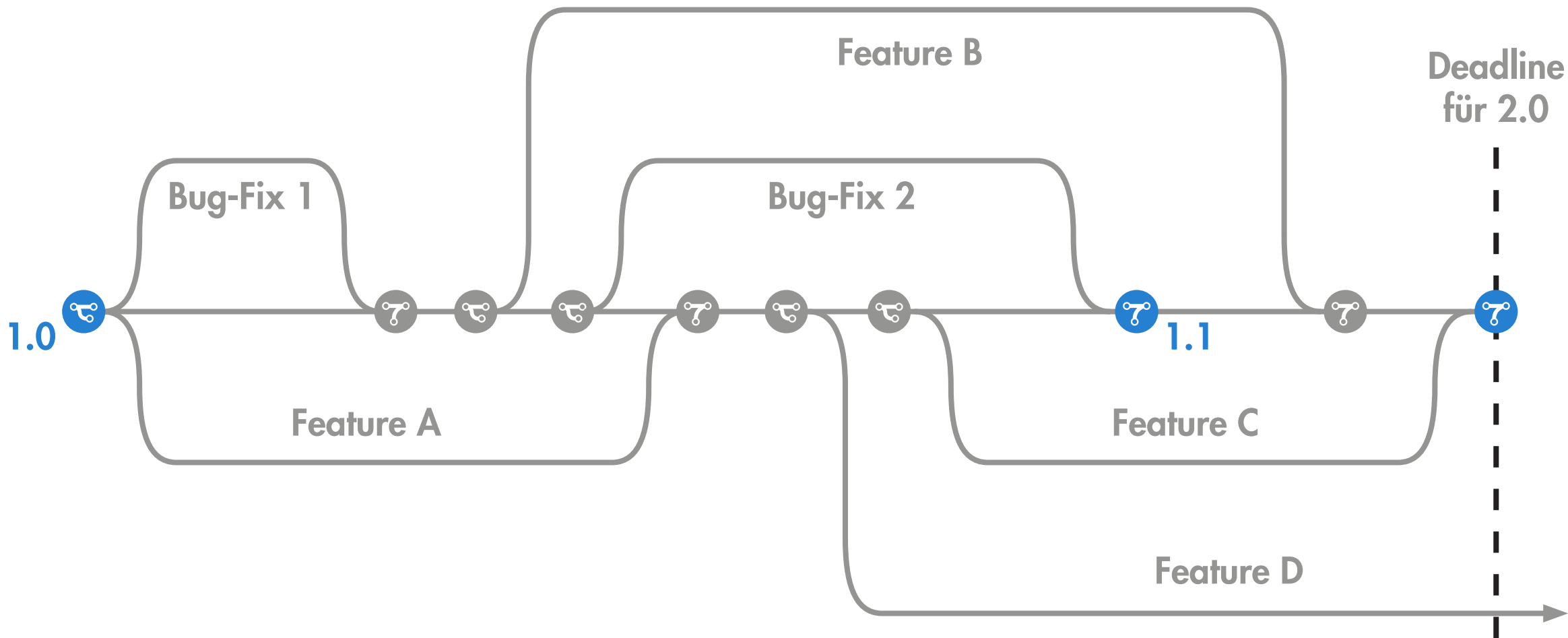
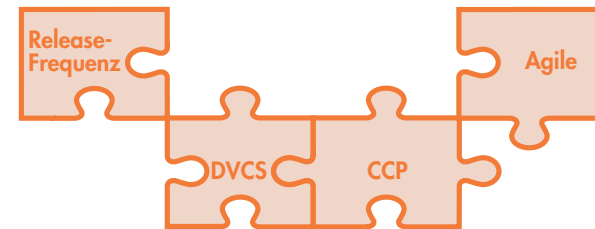

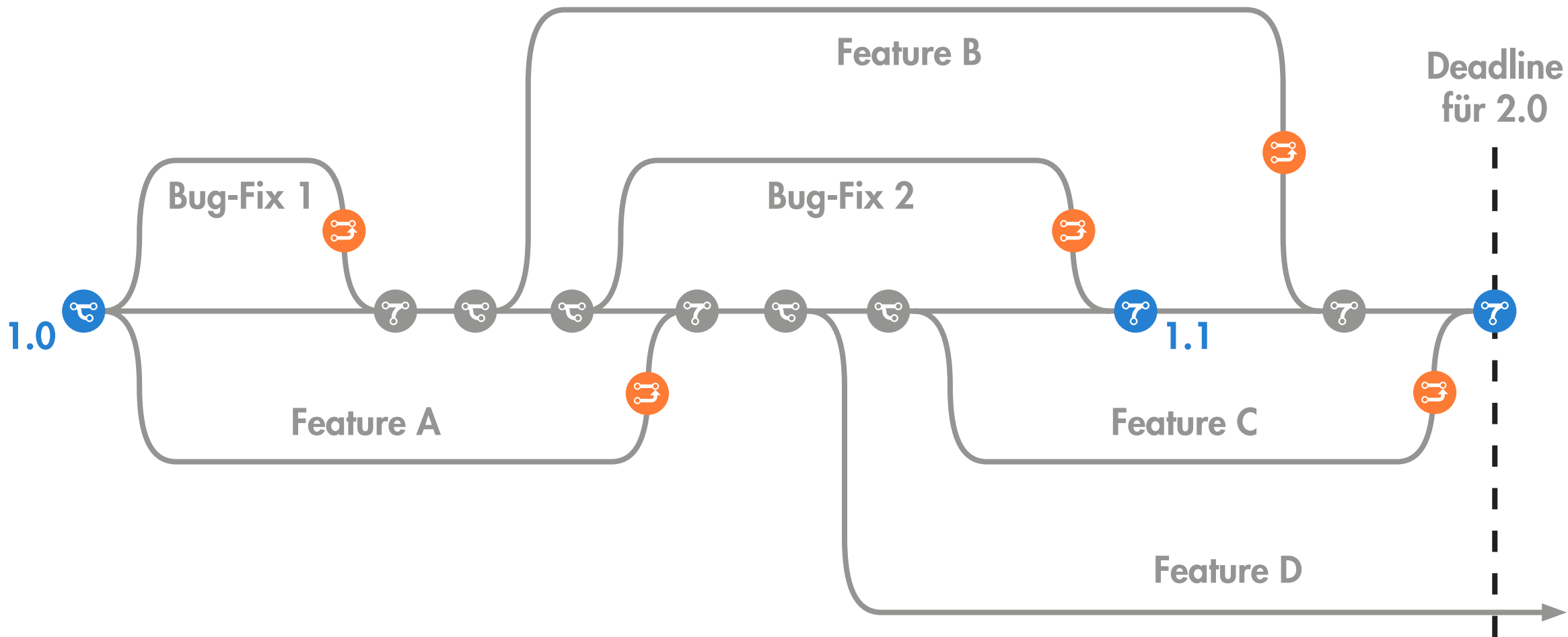
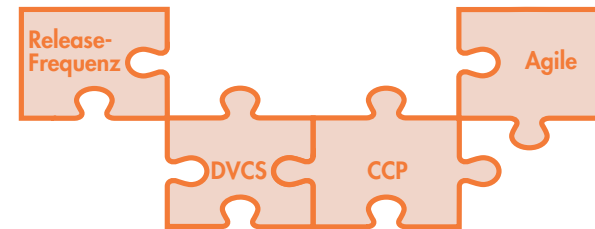

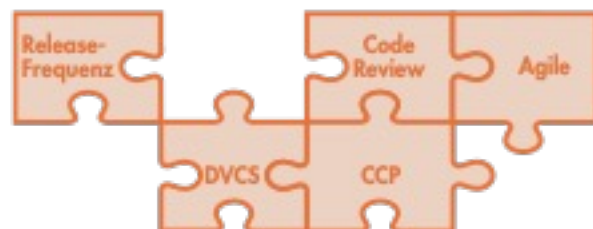

Discussion 1 Commits 2 Pipelines 2 Changes 1

Show all activity

1/1 thread resolved



Andreas Sewe @sewe started a thread on an old version of the diff 4 months ago  
Resolved by Lars Heinemann 4 months ago

[Toggle thread](#)

`engine/org.conqat.engine.index/src/org/conqat/engine/index/repository/RepositoryContentUpdaterBase.java`

```
293 293         List<BasicTokenElementInfo> tokenElements = tokenElementIndex.getValues(paths);
294 294         for (int i = 0; i < paths.size(); i++) {
295 295             String path = paths.get(i);
296 -             RepositoryChangeInfo changeInfo = changeSet.getChangeInfo(path);
297 -             ERepositoryChangeType changeType = patchChangeType(changeInfo,
                tokenElements.get(i));
298 -             if (changeType != null) {
299 -                 result.add(new RepositoryChangeEntry(path,
300 -                     requiredNode.getRevision().getRevision(), changeType,
301 -                         commit, changeInfo.getOriginPath(),
302 -                             changeInfo.getOriginCommit()));
303 +             BasicTokenElementInfo element = tokenElements.get(i);
304 +             addChangeEntry(requiredNode, result, changeSet, path, element);
```



Andreas Sewe @sewe · 4 months ago

Maintainer

I would re-order the message signature. ATM, it's hard to tell which parameter the change entry is added to. If you have `result` first, as in `result.add(...)` things become clearer.

Alternatively, let the extracted method return `Optional<RepositoryChangeEntry>` and do the `add` here.

```
computeChangeEntry(requiredNode, changeSet, path, element).ifPresent(result::add);
```



Lars Heinemann @heinemann changed this line in version 2 of the diff 4 months ago



Reply...

Unresolve thread





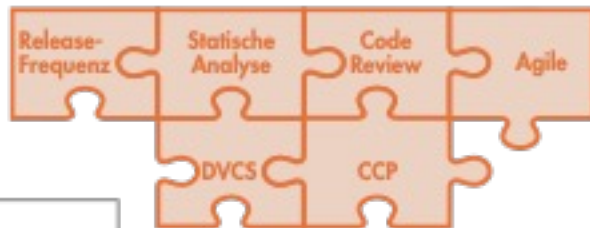

## PR #4

nkxater wants to merge 22 commits into `master` from `firstbranch`

Conversation 0 Commits 22 Checks 1 Files changed 1

Changes from all commits File filter... Jump to...

4 jabref/jabRefGUI.java

@@ -35,7 +35,7 @@

```
35
36 public class JabRefGUI {
37
38 - @private static final Logger LOGGER = LoggerFactory.getLogger(JabRefGUI.class);
```

```
35
36 public class JabRefGUI {
37
38 + public static final Logger LOGGER = LoggerFactory.getLogger(JabRefGUI.class);
```

Check warning on line 38 in jabref/jabRefGUI.java  
 Teamscale App / Teamscale Findings  
 jabref/jabRefGUI.java#L38  
 Interface comment missing

2 jabref/logic/bibtex/BibEntryWriter.java

@@ -163,7 +163,7 @@ private void writeField(BibEntry entry, Writer out, String name, int indentation

```
163 try {
164     out.write(fieldFormatter.format(field.get(), name));
165     out.write(", " + OS.NEWLINE);
166 - } catch (InvalidFieldValueException ex) {
167     throw new IOException("Error in field " + name + ": " + ex.getMessage(), ex);
168 }
```

```
163 try {
164     out.write(fieldFormatter.format(field.get(), name));
165     out.write(", " + OS.NEWLINE);
166 + } catch (Exception ex) {
167     throw new IOException("Error in field " + name + ": " + ex.getMessage(), ex);
168 }
```

Check failure on line 166 in jabref/logic/bibtex/BibEntryWriter.java  
 Teamscale App / Teamscale Findings  
 jabref/logic/bibtex/BibEntryWriter.java#L166-L168  
 Catch clause catches generic exception 'Exception'



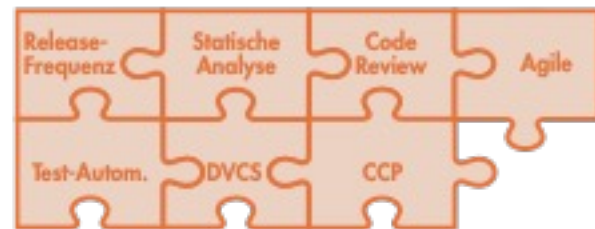

## Cr/20002 new report template

Edited 9 hours ago by build



**Request to merge** cr/20002\_new\_report\_t\_ into teamscale/v5.4.x

The source branch is 31 commits behind the target branch

Open in Web IDE

Check out branch



**Pipeline #89447 failed for 040f1ce9 on cr/20002\_new\_report\_t\_**



Test summary contained 5 failed test results out of 4318 total tests

Expand



**Merge**



Delete source branch



Squash commits



**8 commits** and **1 merge commit** will be added to teamscale/v5.4.x. [Modify merge commit](#)

*You can merge this merge request manually using the command line*

## Cr/20002 new report template

Edited 9 hours ago by build



**Request to merge** cr/20002\_new\_report\_t\_ into teamscale/v5.4.x  
The source branch is 31 commits behind the target branch

Open in Web IDE

Check out branch



**Pipeline #89447 failed for 040f1ce9 on cr/20002\_new\_report\_t\_**



Test summary contained 5 failed test results out of 4318 total tests



integration-tests found no changed test results out of 2040 total tests



system-tests found no changed test results out of 193 total tests



ui-tests found 5 failed test results out of 29 total tests



**New** IssueDetailTest.testCompareLinks



**New** deleteArchitectureUpload()



**New** ProjectActivityChartTest.testProjectActivityChartPage



**New** testDuplicateSlides()



**New** createReportWithArchitectureAndBaselineAndHead()



unit-tests found no changed test results out of 1919 total tests



js-tests found no changed test results out of 137 total tests

Summary of test results for the failed pipeline:

- ui-tests: Failed (indicated by a red 'x' icon)
- dotnet-tests: Passed (indicated by a green checkmark icon)
- integration-tests: Passed (indicated by a green checkmark icon)
- js-tests: Passed (indicated by a green checkmark icon)
- system-tests: Passed (indicated by a green checkmark icon)
- ui-tests-common-lang: Passed (indicated by a green checkmark icon)

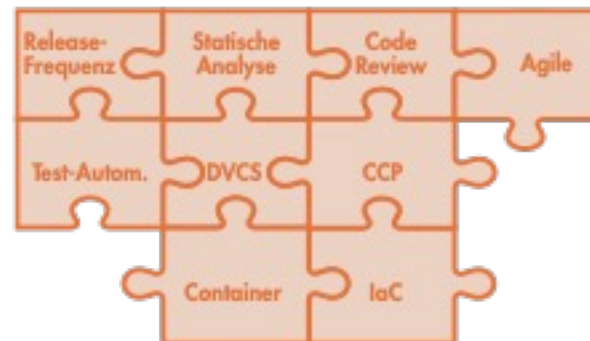

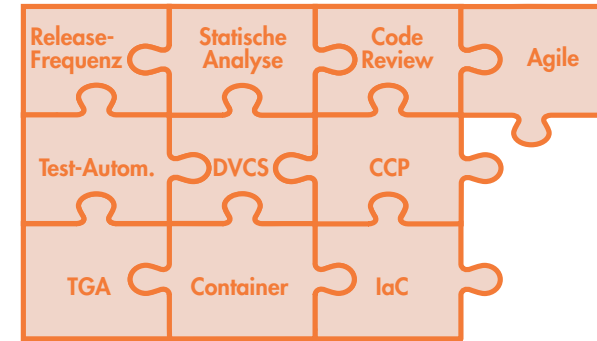

**Done** Issue TS-14733 - Remove Dataflow blocks

Last update: Aug 24 2018 09:32

Creator:  (on Apr 06 2018 19:44)

Assignee: 

Project	Type	Priority	Resolution	Fix Version
TS	Maintenance	Normal	Green	Teamscale 4.5
Component	Labels	Affected Version	Customer	Customer Issue
Backend	Performance			
Epic Name	Freshdesk URL	Merge Request		
		<a href="https://git.cqse.eu/cqse/teamscale/3621">https://git.cqse.eu/cqse/teamscale/3621</a>		

Aug 15 2018 12:37-Now | Test Gap: 22%

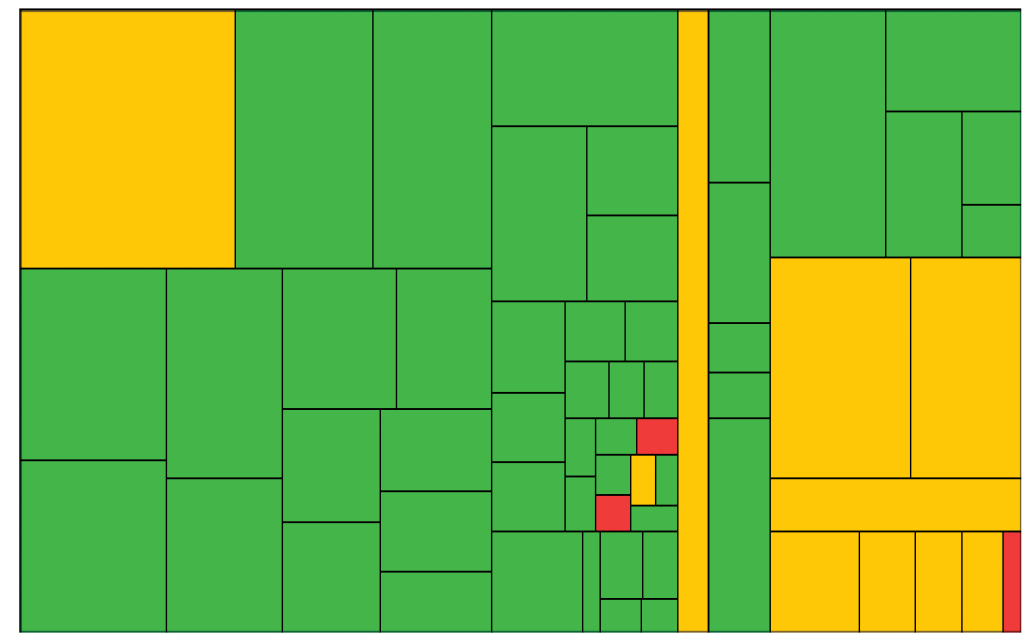

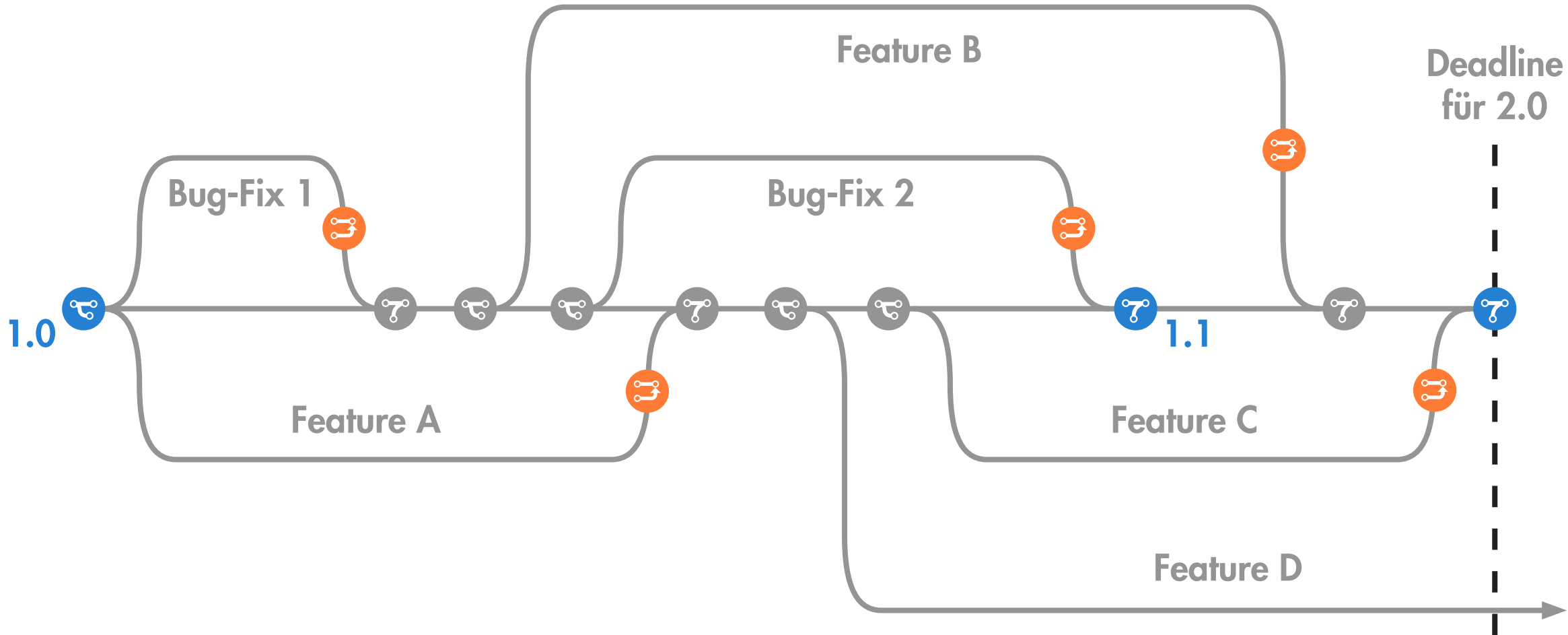
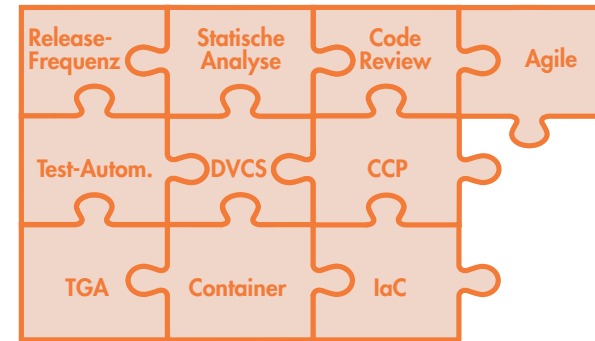

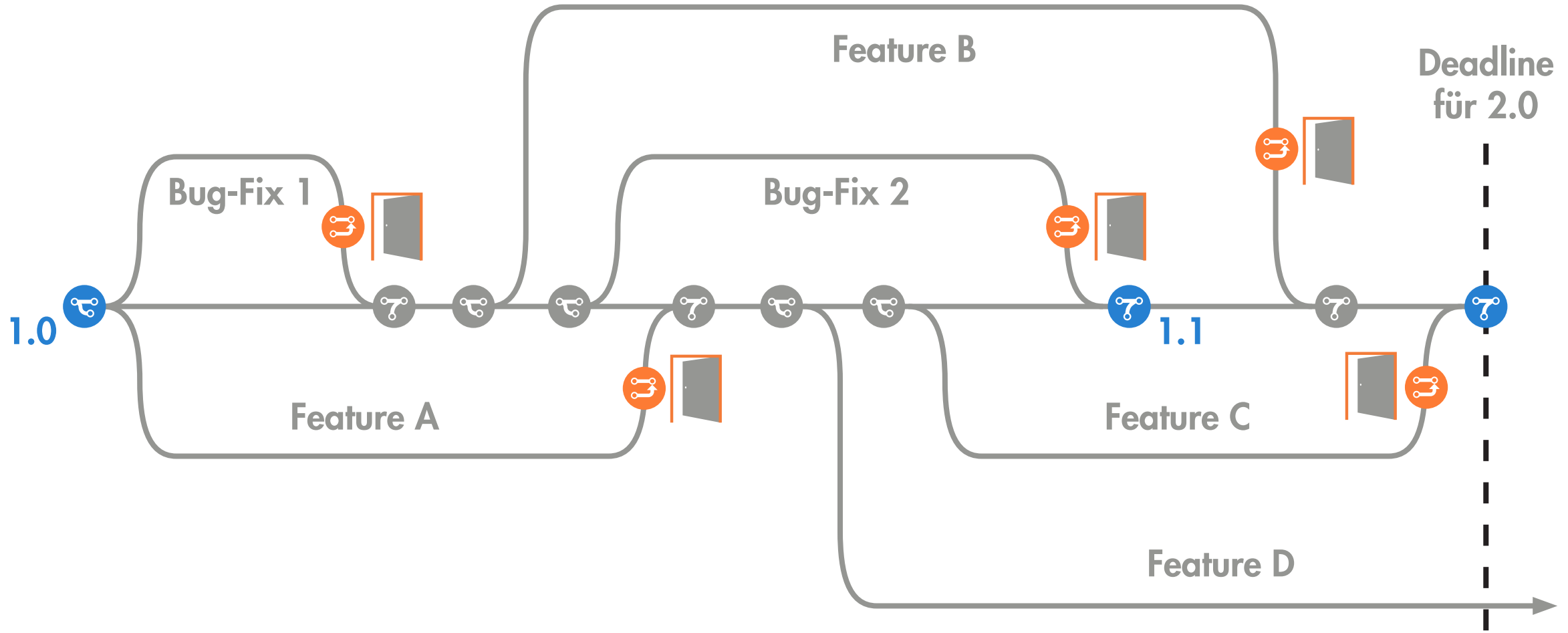
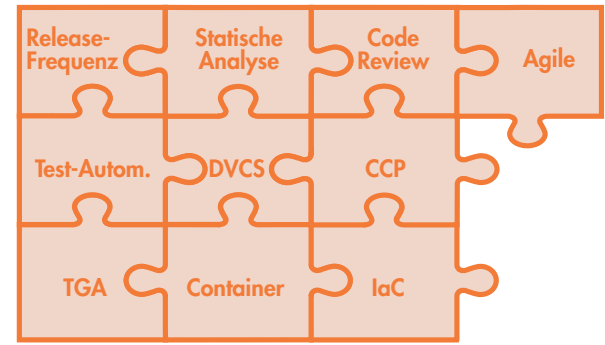

- ✔ Schnell
- ✔ Spezifisch
- ✔ Explizit

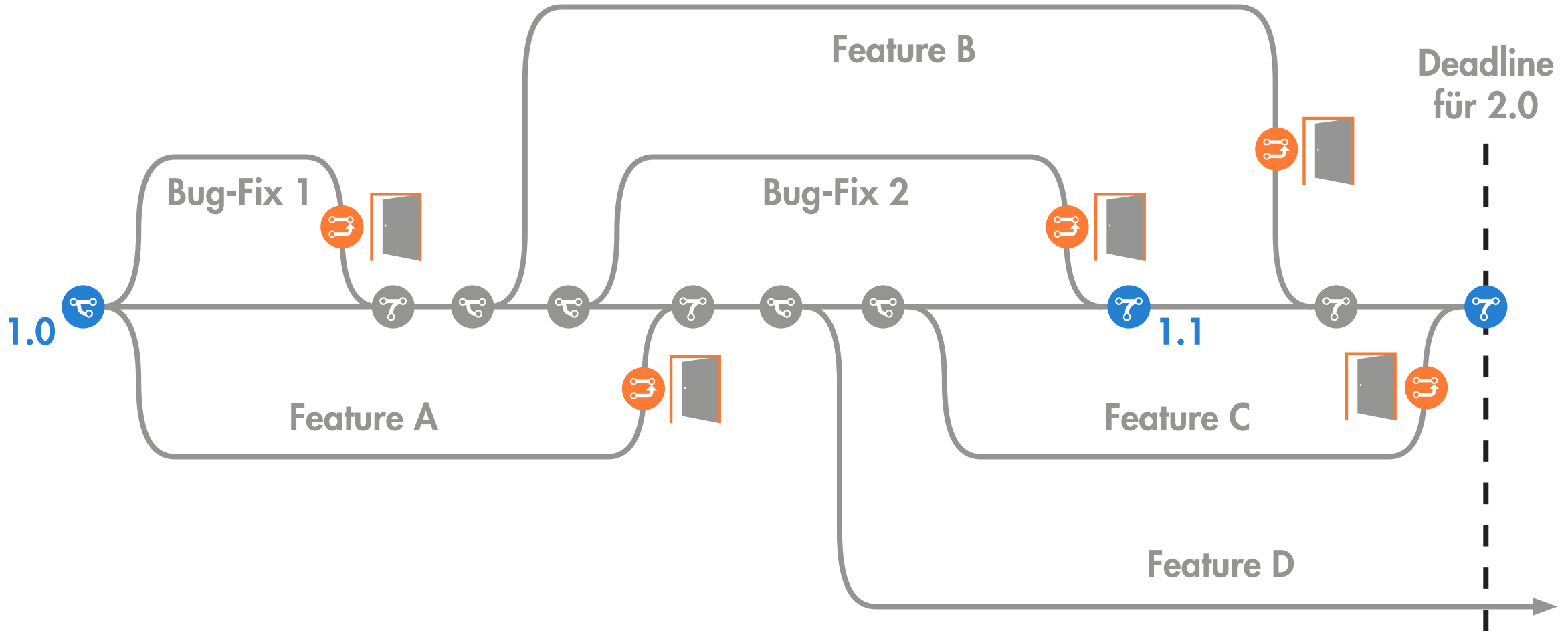
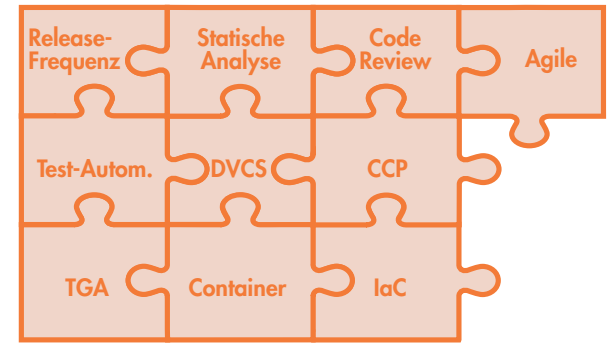

? Schnell

✓ Spezifisch

✓ Explizit

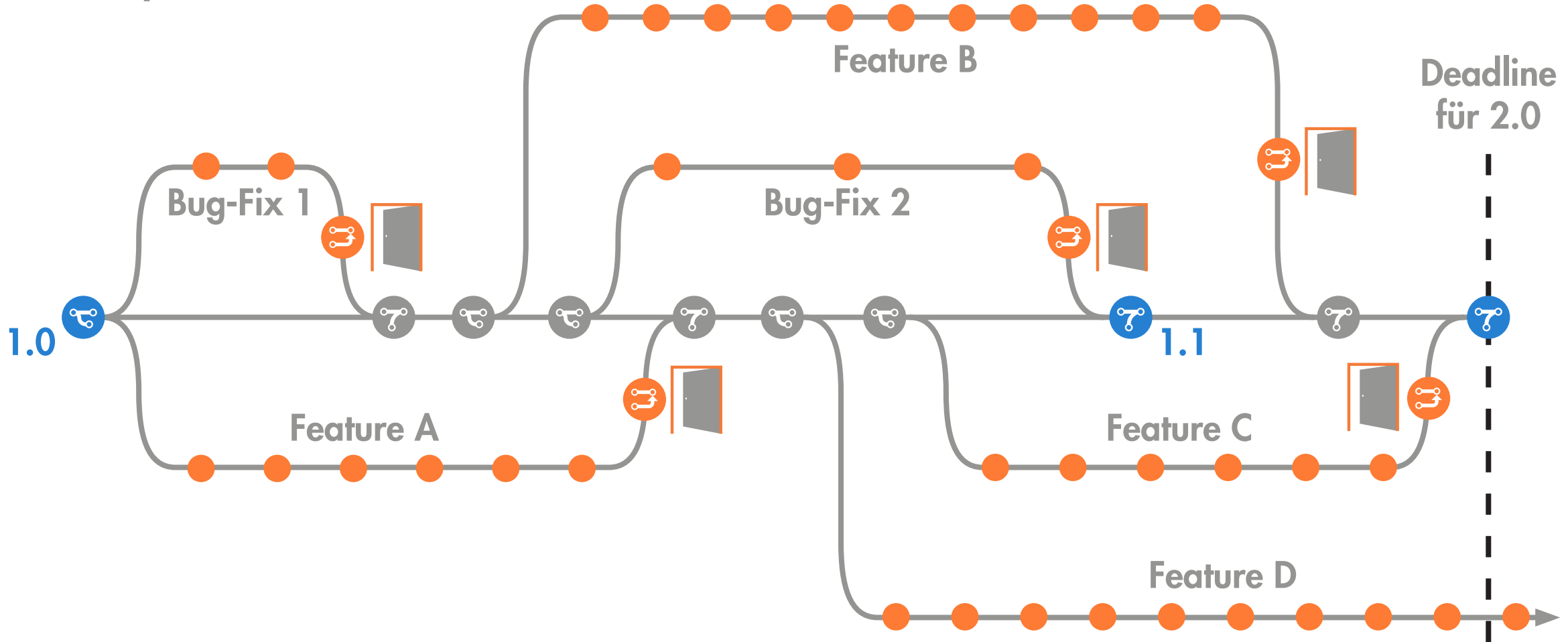
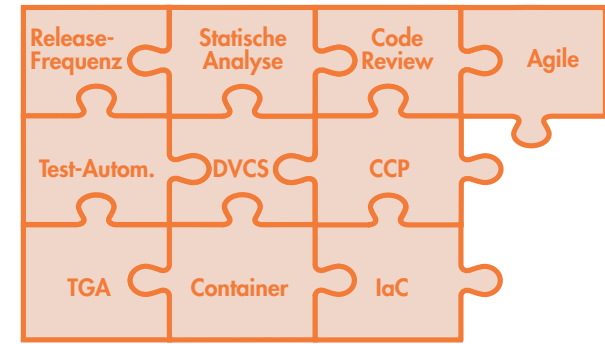



- ✔ Schnell
- ✔ Spezifisch
- ✔ Explizit

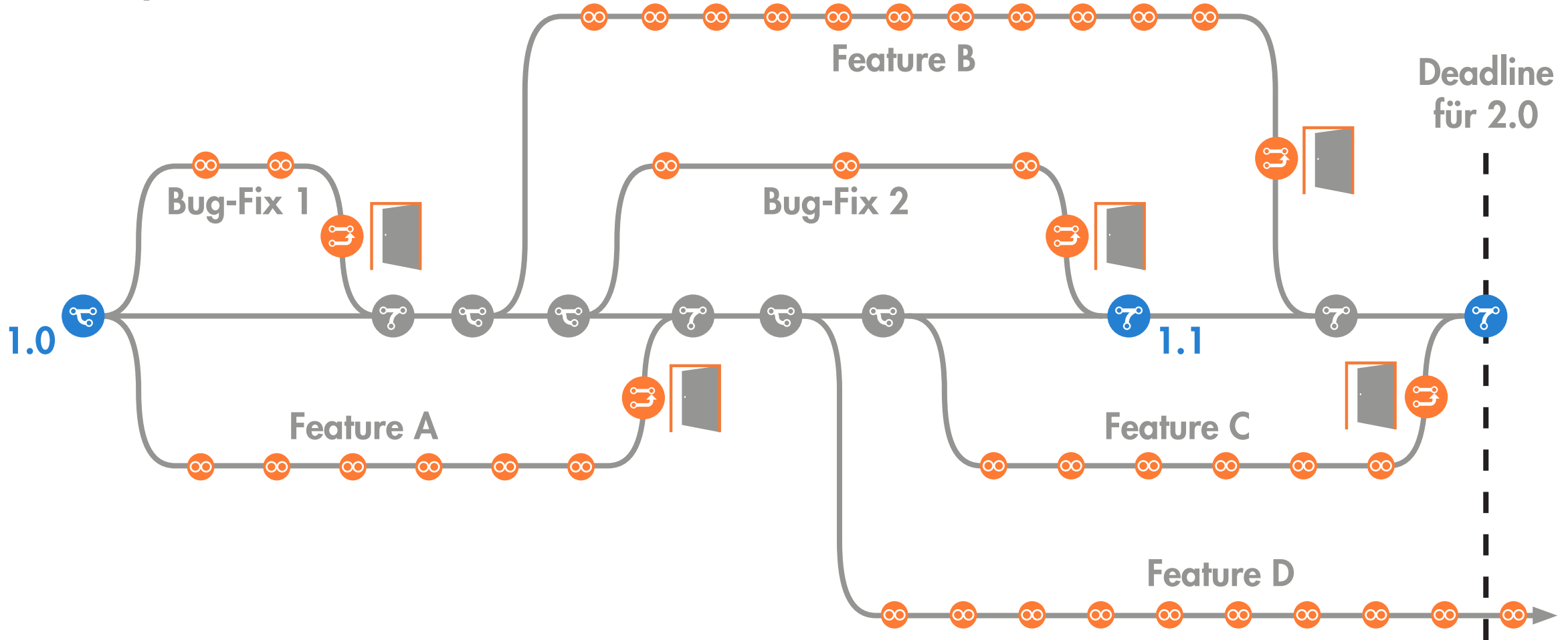
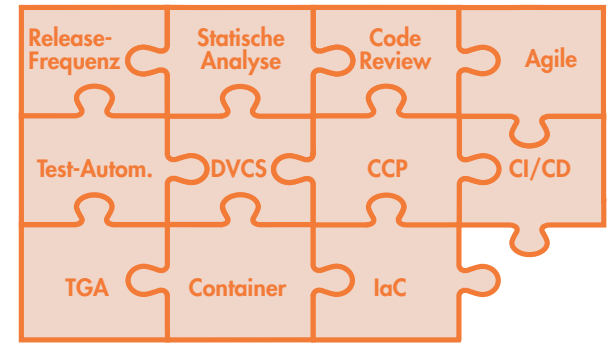

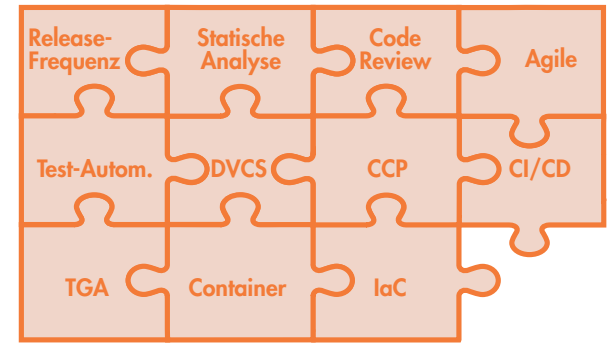
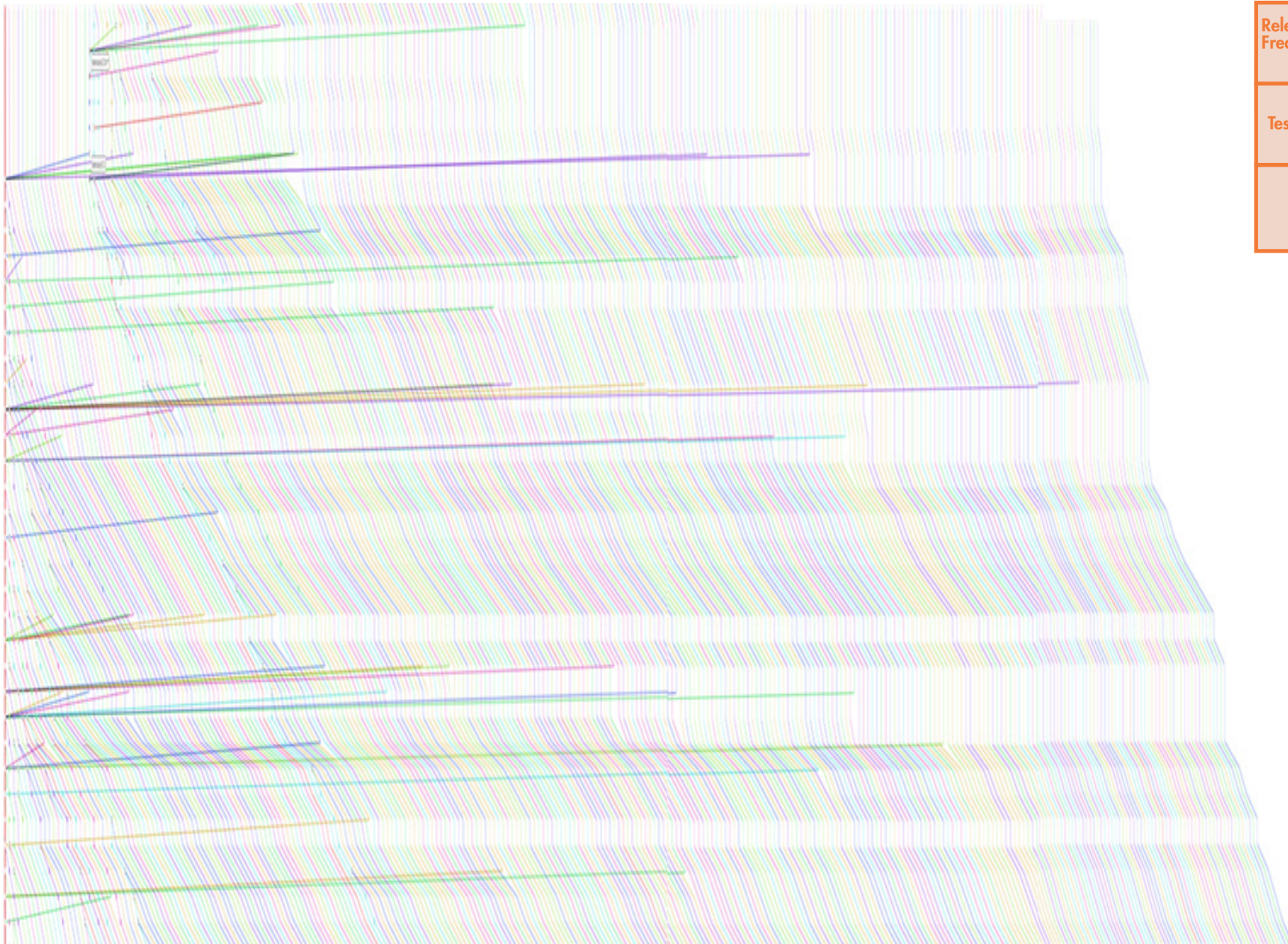

# LOC	1.073.401
# Entwickler	20
# Offene Merge Requests	227
# Automatisierte Tests	8.011
Testausführungsdauer	6.098 s
# Commits/h	2,2
# Build Jobs/h	25
# Build Server	7

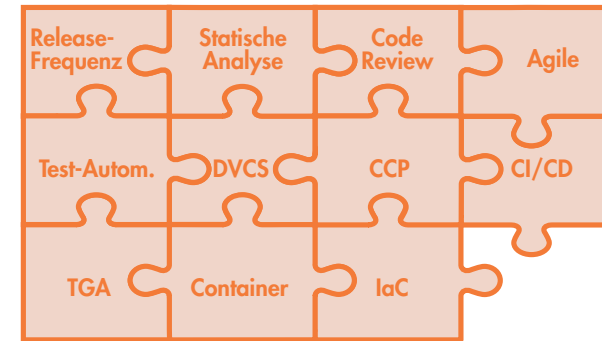

# LOC 1.073.401

---

# Entwickler 20

---

# Offene Merge Requests 227

---

# Automatisierte Tests 8.011

---

Testausführungsdauer 6.098 s

---

# Commits/h 2,2

---

# Build Jobs/h 25

---

# Build Server 7

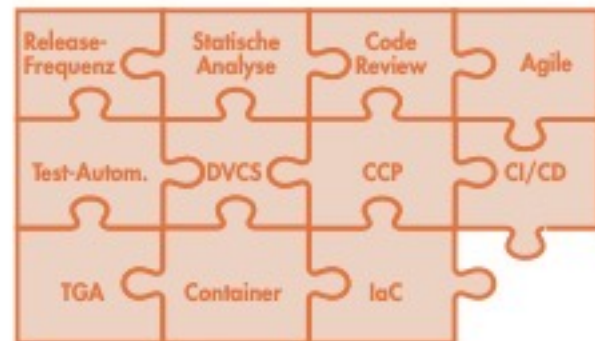

## Test-Impact-Analyse (TIA)

# Fast Feedback From Long-Running Tests

Test-Impact Analysis and Pareto Optimization  
for Ever-Growing Test Suites

Mittwoch, 20. Juli 2022

17:00 bis 18:30 CEST

Registrierung:

[cqse.eu/workshop-8020-en-2206-saec](https://cqse.eu/workshop-8020-en-2206-saec)



Dr. Elmar Jürgens



Fabian Streitl

**# LOC** **1.073.401**

---

**# Entwickler** **20**

---

**# Offene Merge Requests** **227**

---

**# Automatisierte Tests** **8.011**

---

**Testausführungsdauer** **6.098 s**

---

**# Commits/h** **2,2**

---

**# Build Jobs/h** **25**

---

**# Build Server** **7**

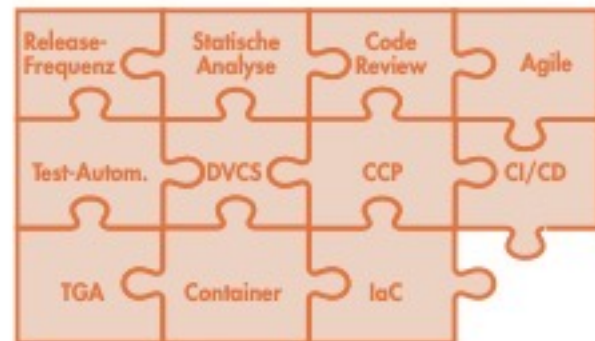

# LOC 1.073.401

---

# Entwickler 20

---

# Offene Merge Requests 227

---

# Automatisierte Tests 8.011

---

Testausführungsdauer 6.098 s

---

# Commits/h 2,2

---

# Build Jobs/h 25

---

# Build Server 7

**Max**

**26**

**257**

**100**

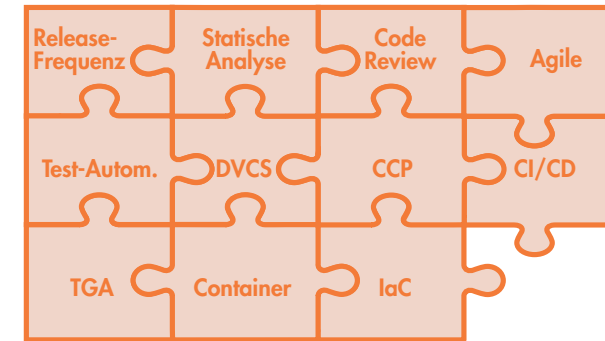

# LOC 1.073.401

---

# Entwickler 20

---

# Offene Merge Requests 227

---

# Automatisierte Tests 8.011

---

Testausführungsdauer 6.098 s

---

# Commits/h 2,2

---

# Build Jobs/h 25

---

# Build Server 7

**Max**

**26**

**257**

**100**

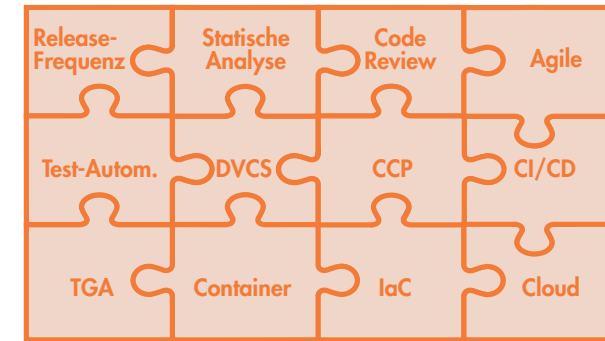



# LOC 1.073.401

---

# Entwickler 20

---

# Offene Merge Requests 227

---

# Automatisierte Tests 8.011

---

Testausführungsdauer 6.098 s

---

# Commits/h 2,2

---

# Build Jobs/h 25

---

# Build Server 7

---

Kosten/Monat 600 €

**Max**

**26**

**257**

**100**

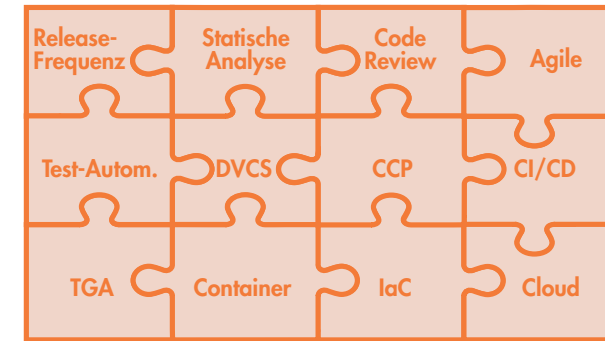

Release-  
Frequenz

Statische  
Analyse

Code  
Review

Agilität

Test-Auto-  
matisierung

DVCS

Code  
Collaboration  
Platforms

CI/CD

Test-  
Gap-  
Analyse

Container

Infrastructure  
as  
Code

Cloud-  
Plattformen

