

Qualitäts-Türchen statt Quality-Gates

Frankfurter Entwicklertag · 4. März 2021

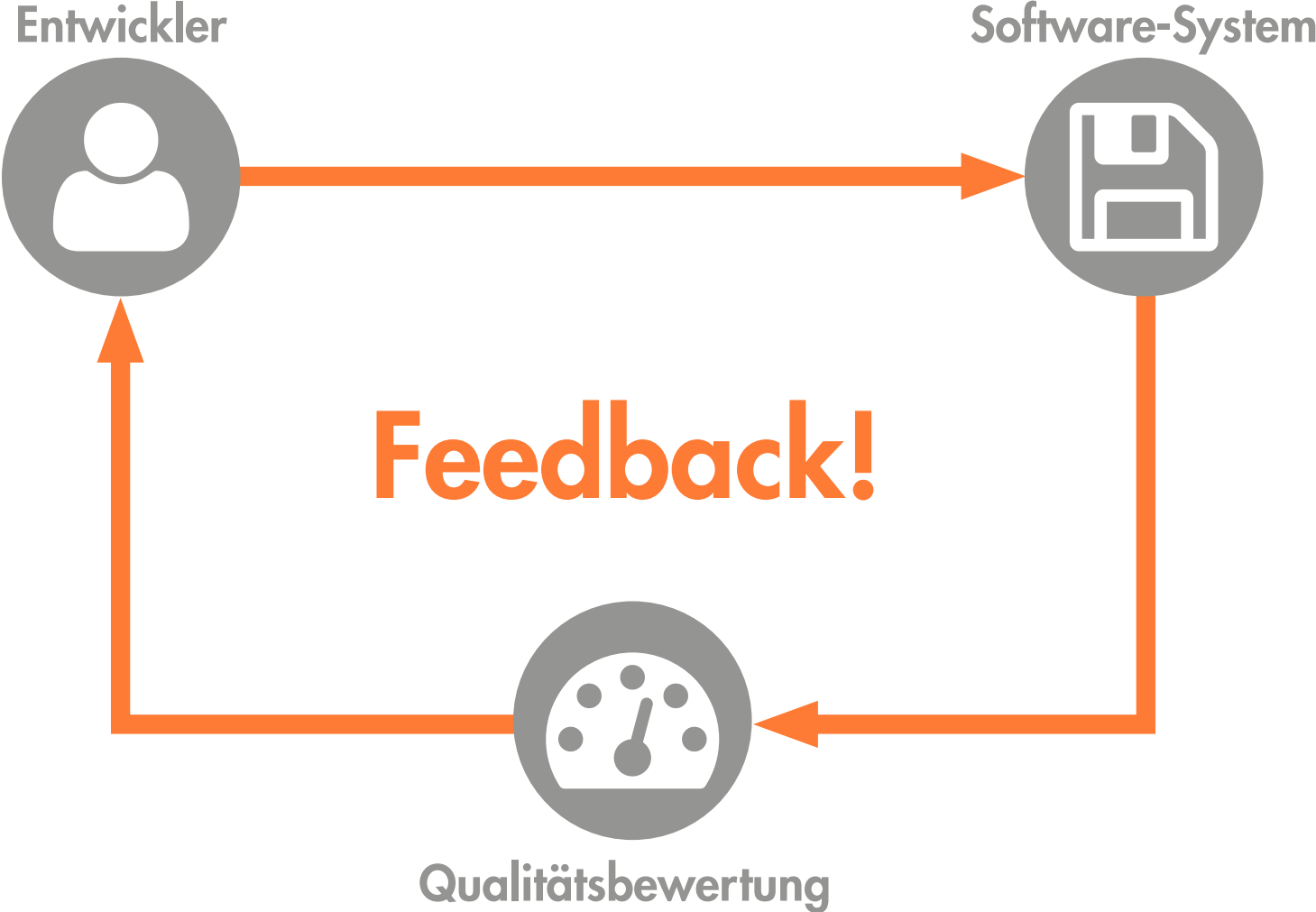

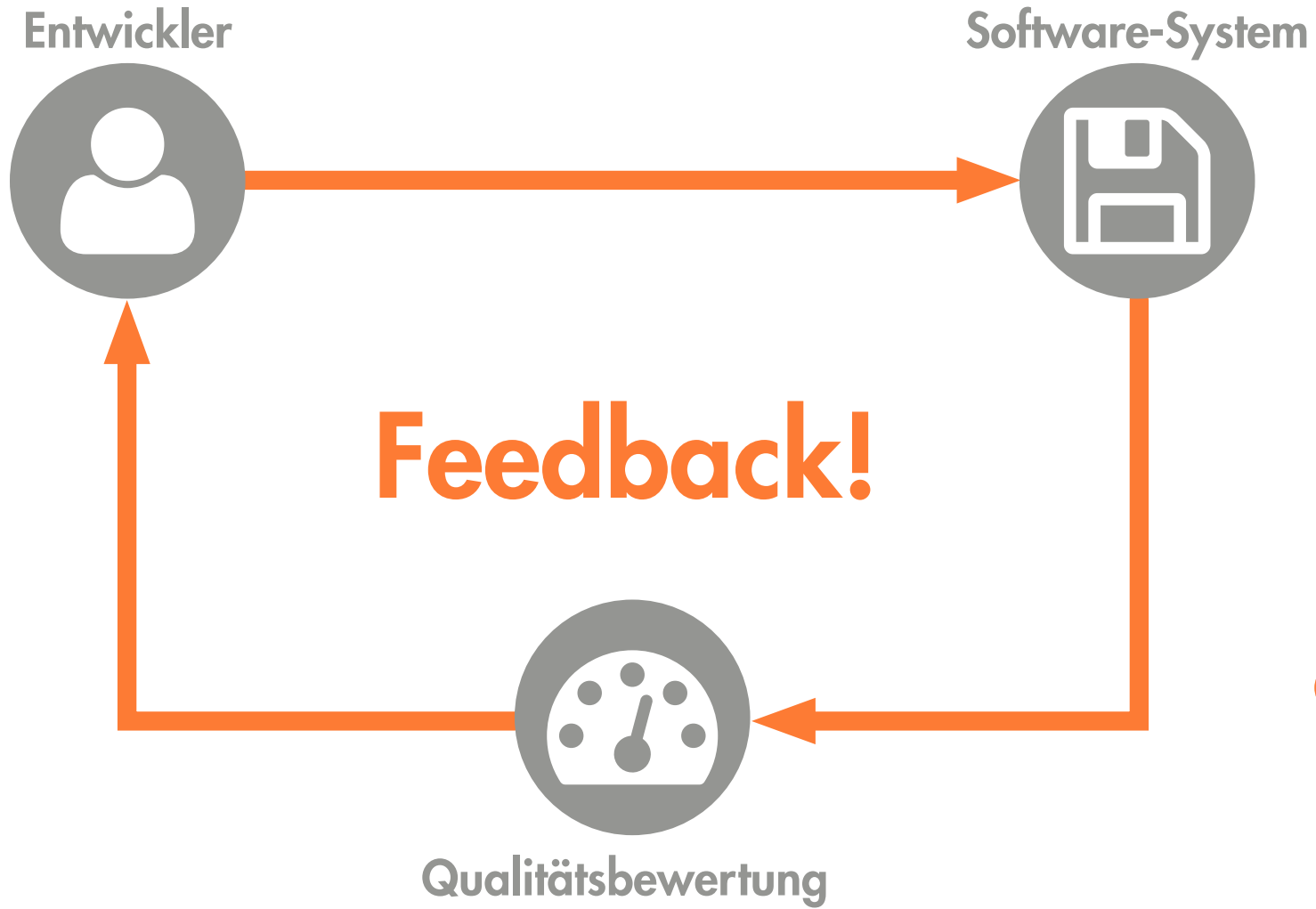

i Schnell

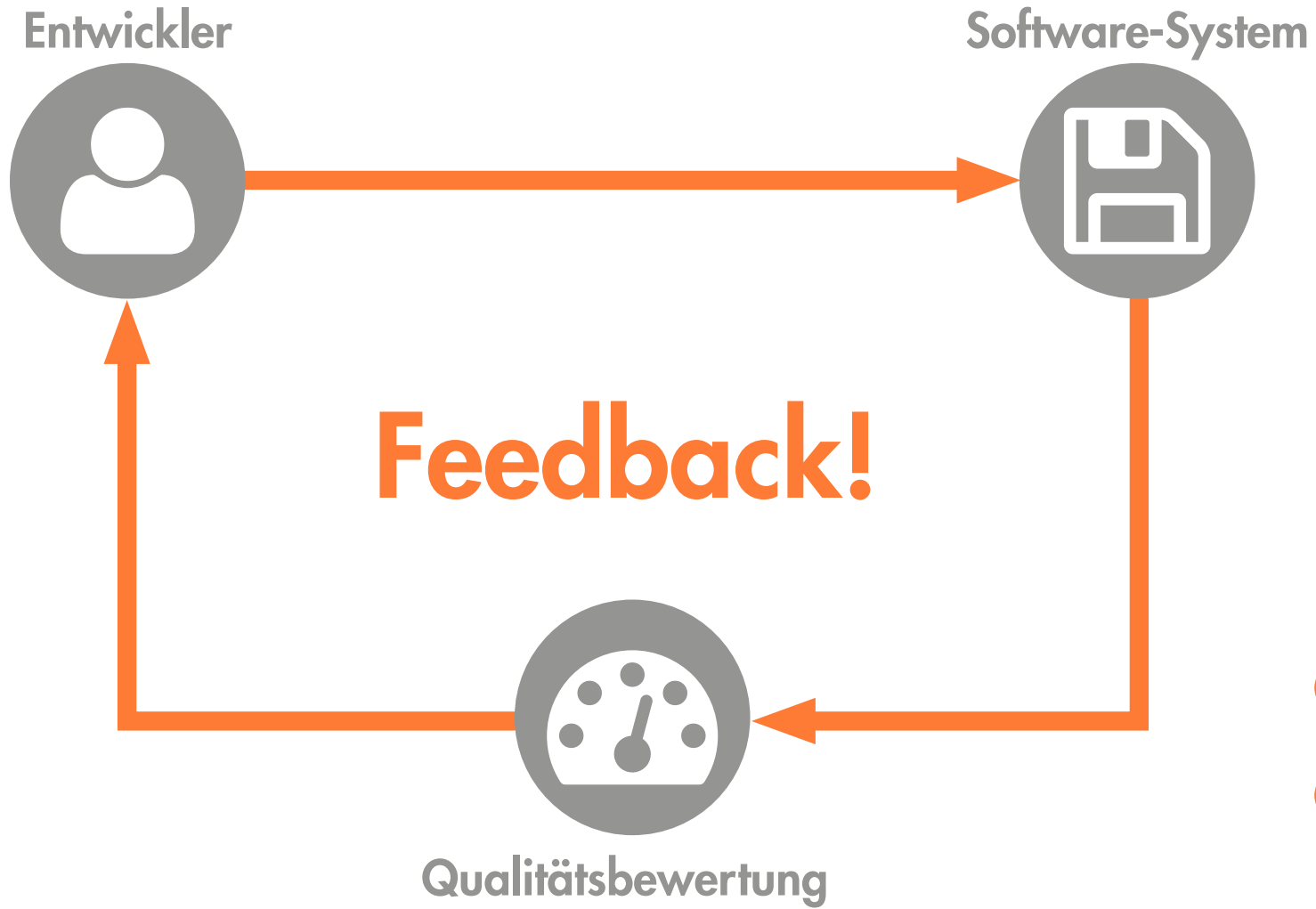

- i** Schnell
- i** Spezifisch

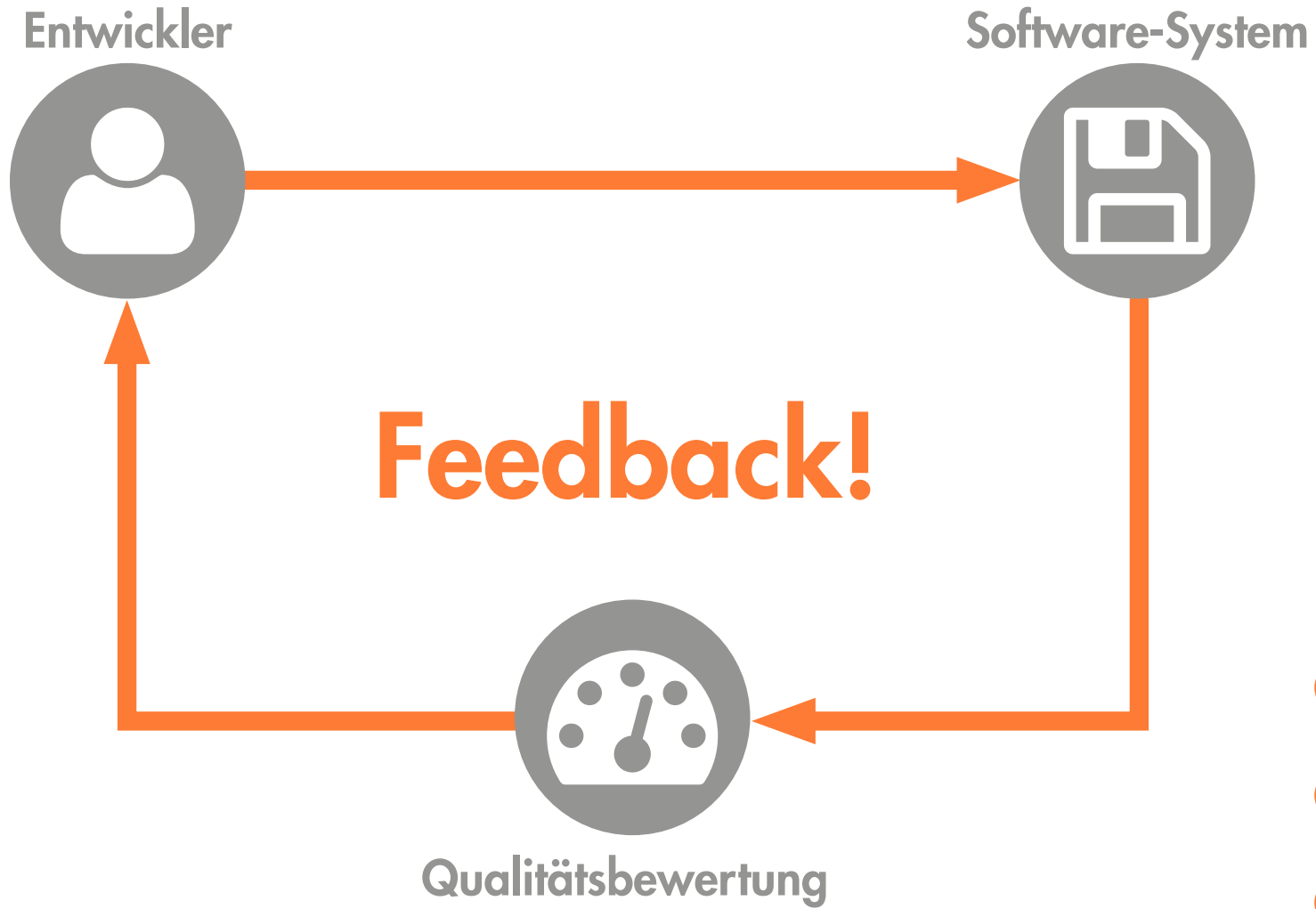

- i** Schnell
- i** Spezifisch
- i** Explizit

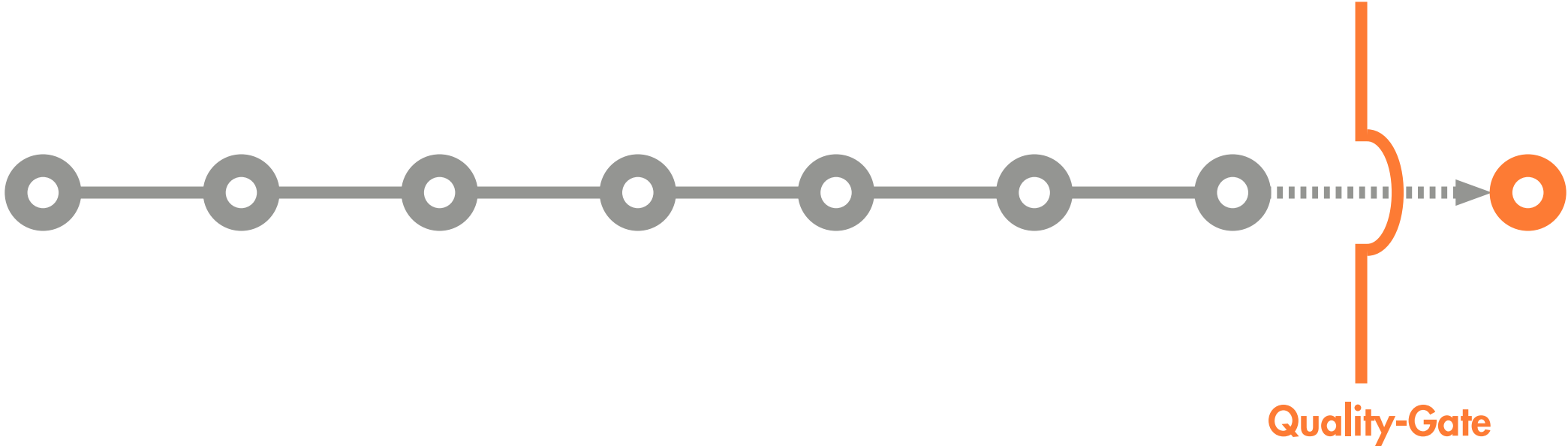

平成六年七月吉日建之

平成二十五年二月吉日建之

御誠和グループ 永田淳世 奥山大輔 川口大介
坂本亮雄 二戸貴之

兵庫県安芸郡山崎町山崎一三六 本店 杉谷收治郎
しずのや食料品店 東店 杉谷昭十九



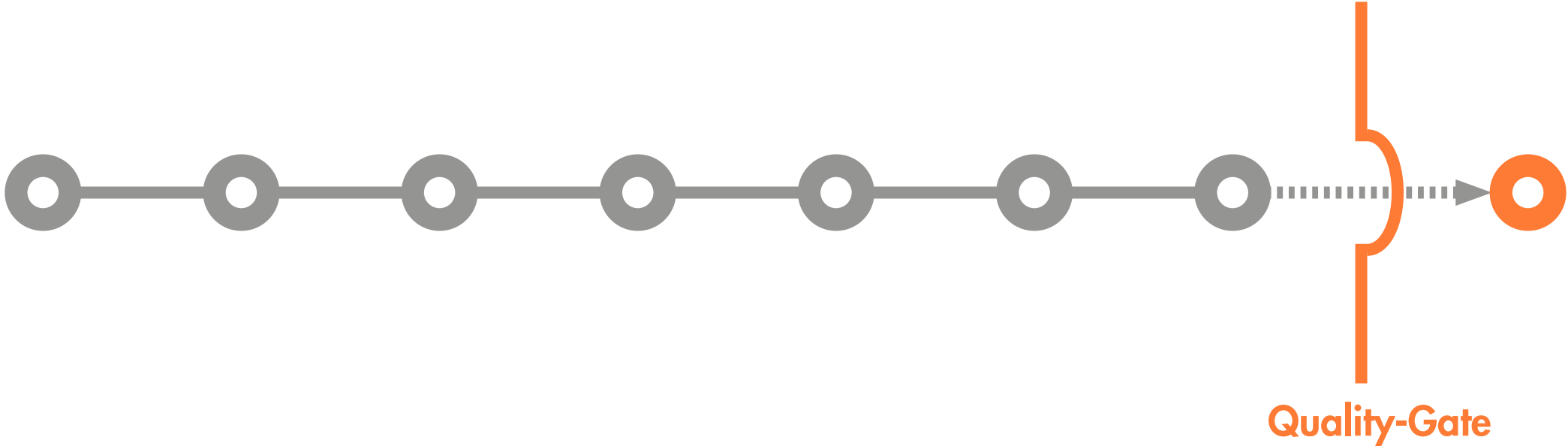

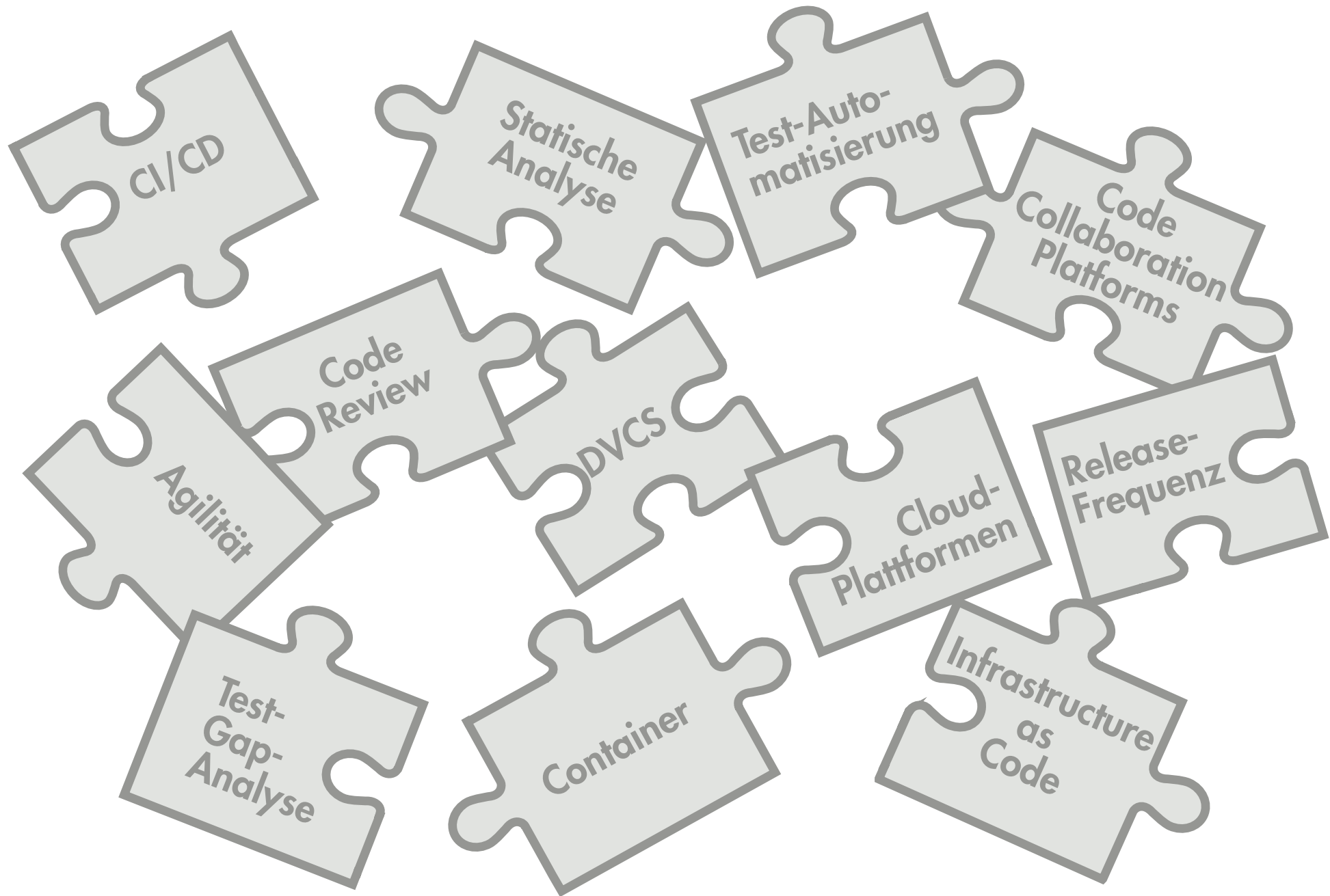

CI/CD

Statische
Analyse

Test-Auto-
matisierung

Code
Collaboration
Platforms

Code
Review

DVCS

Cloud-
Plattformen

Release-
Frequenz

Agilität

Container

Infrastructure
as
Code

Test-
Gap-
Analyse

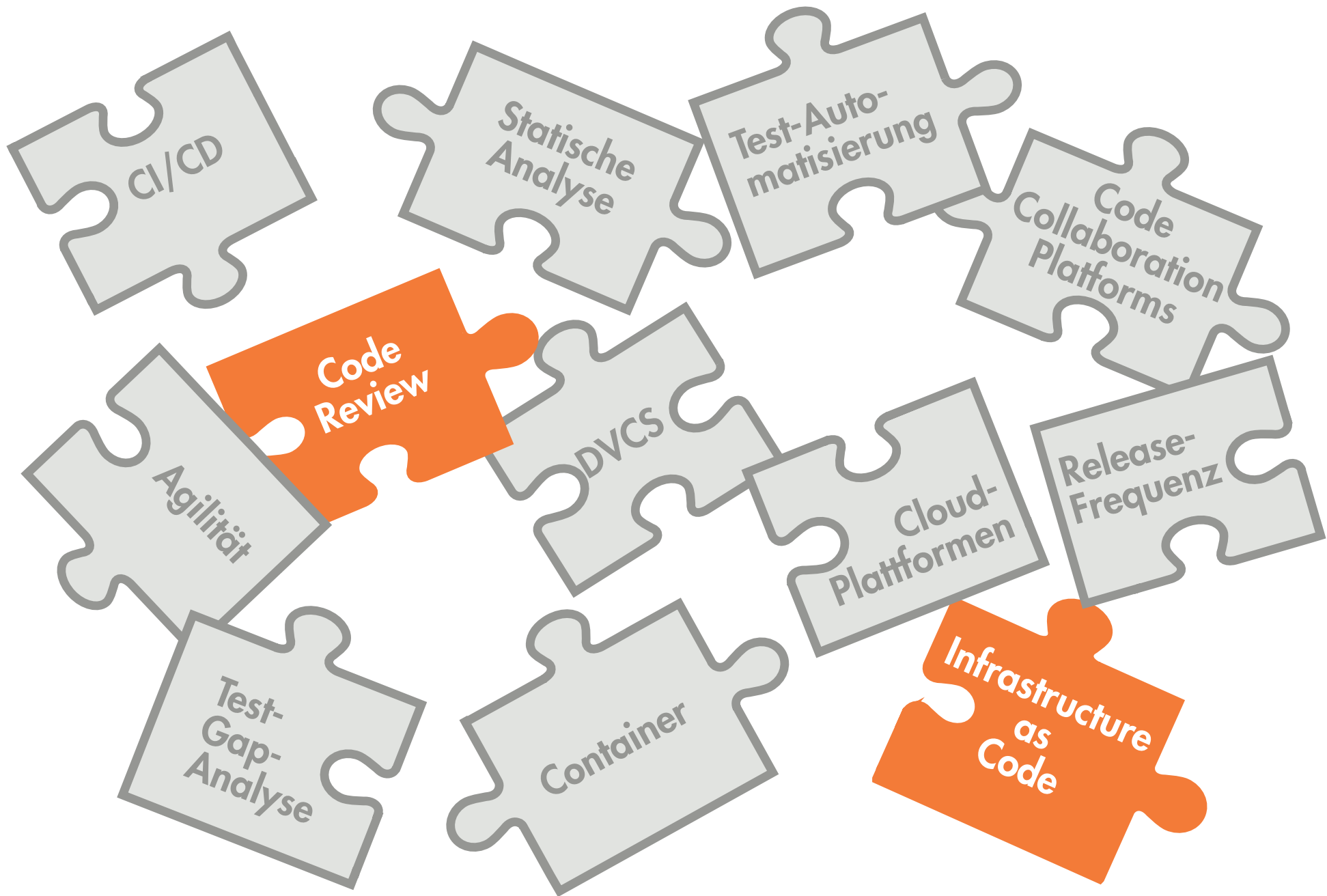

CI/CD

Statische
Analyse

Test-Auto-
matisierung

Code
Collaboration
Platforms

Code
Review

DVCS

Agilität

Cloud-
Plattformen

Release-
Frequenz

Test-
Gap-
Analyse

Container

Infrastructure
as
Code

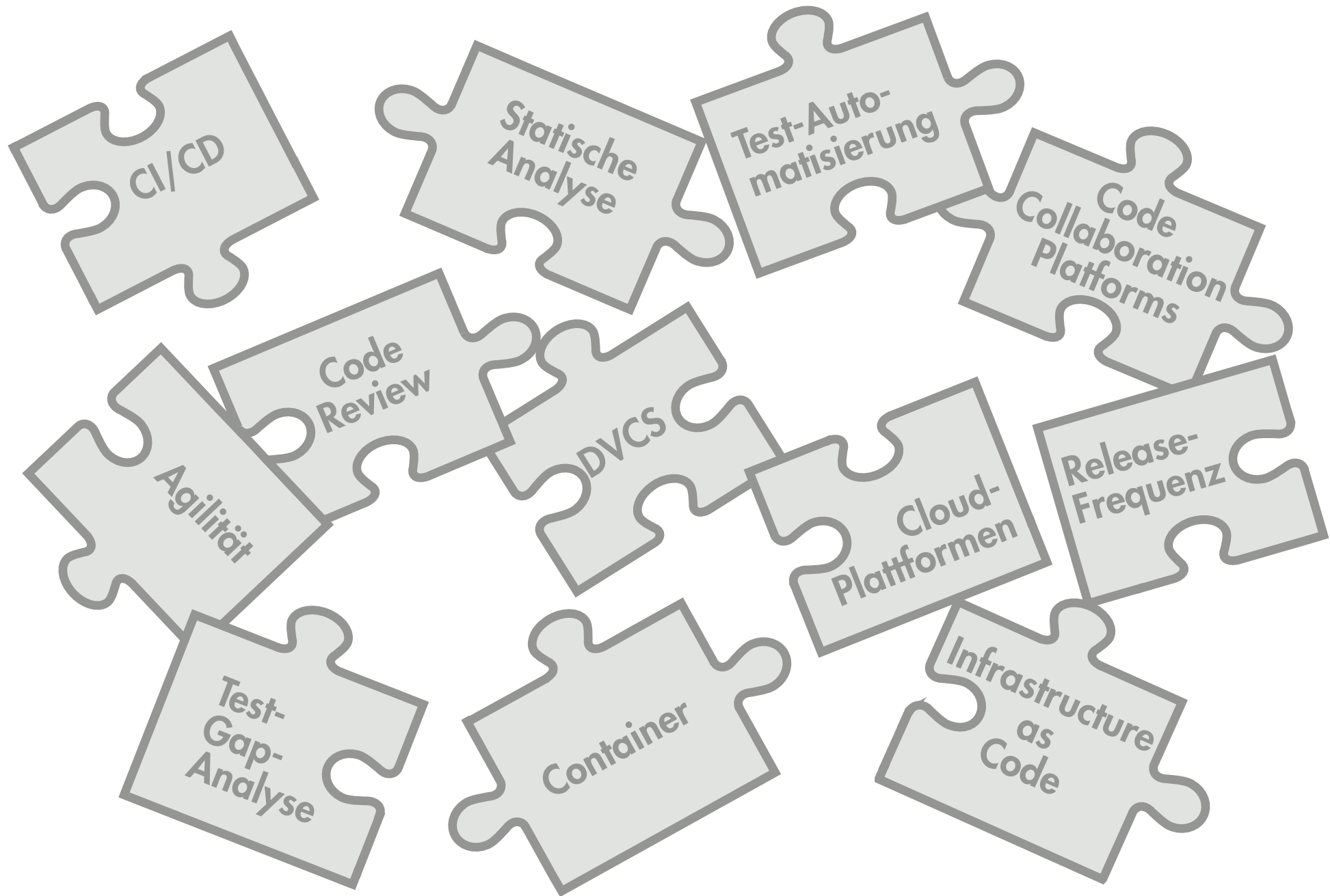

CI/CD

Statische
Analyse

Test-Auto-
matisierung

Code
Collaboration
Platforms

Code
Review

DVCS

Cloud-
Plattformen

Release-
Frequenz

Agilität

Test-
Gap-
Analyse

Container

Infrastructure
as
Code

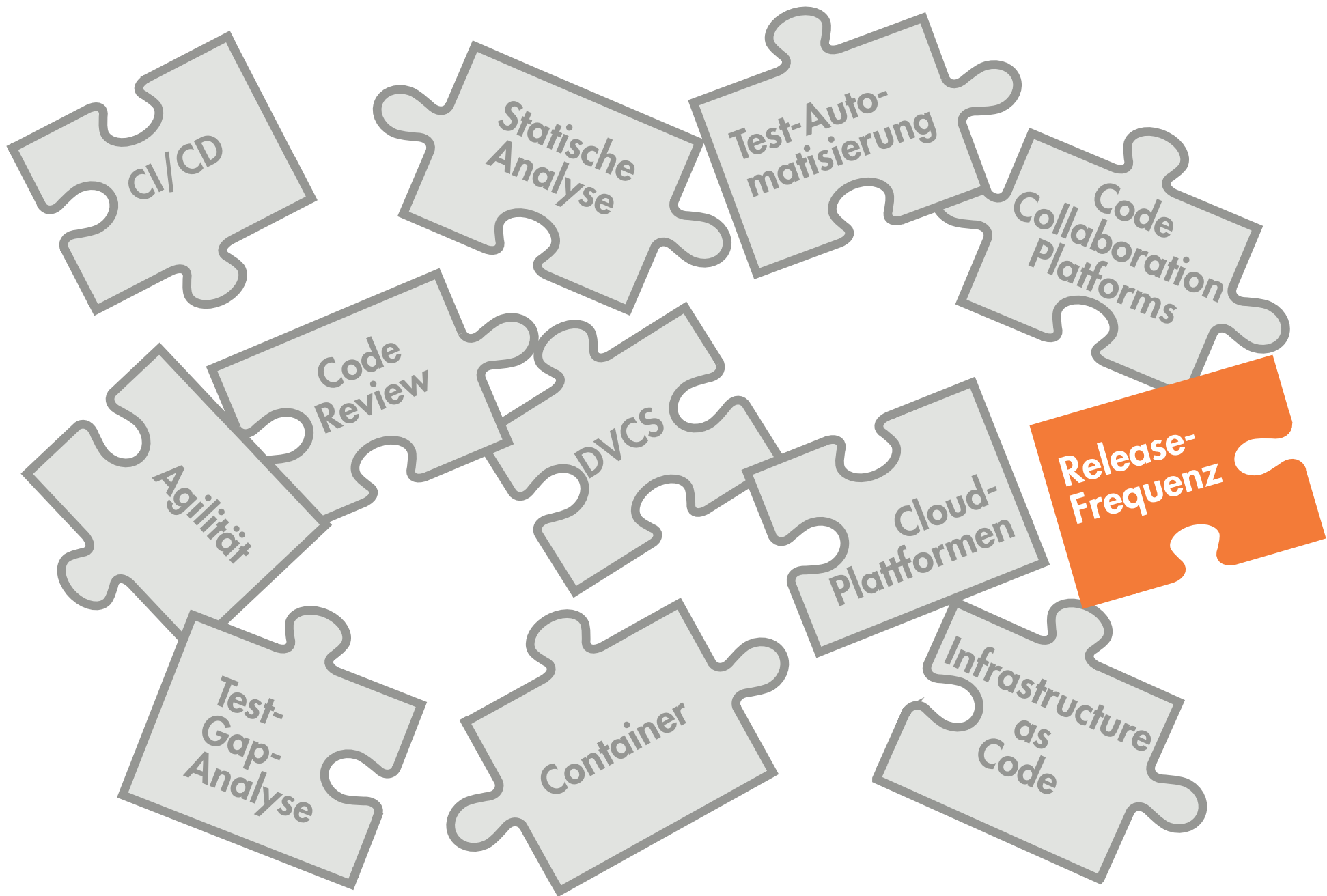

CI/CD

Statische
Analyse

Test-Auto-
matisierung

Code
Collaboration
Platforms

Code
Review

DVCS

Cloud-
Plattformen

Release-
Frequenz

Agilität

Test-
Gap-
Analyse

Container

Infrastructure
as
Code

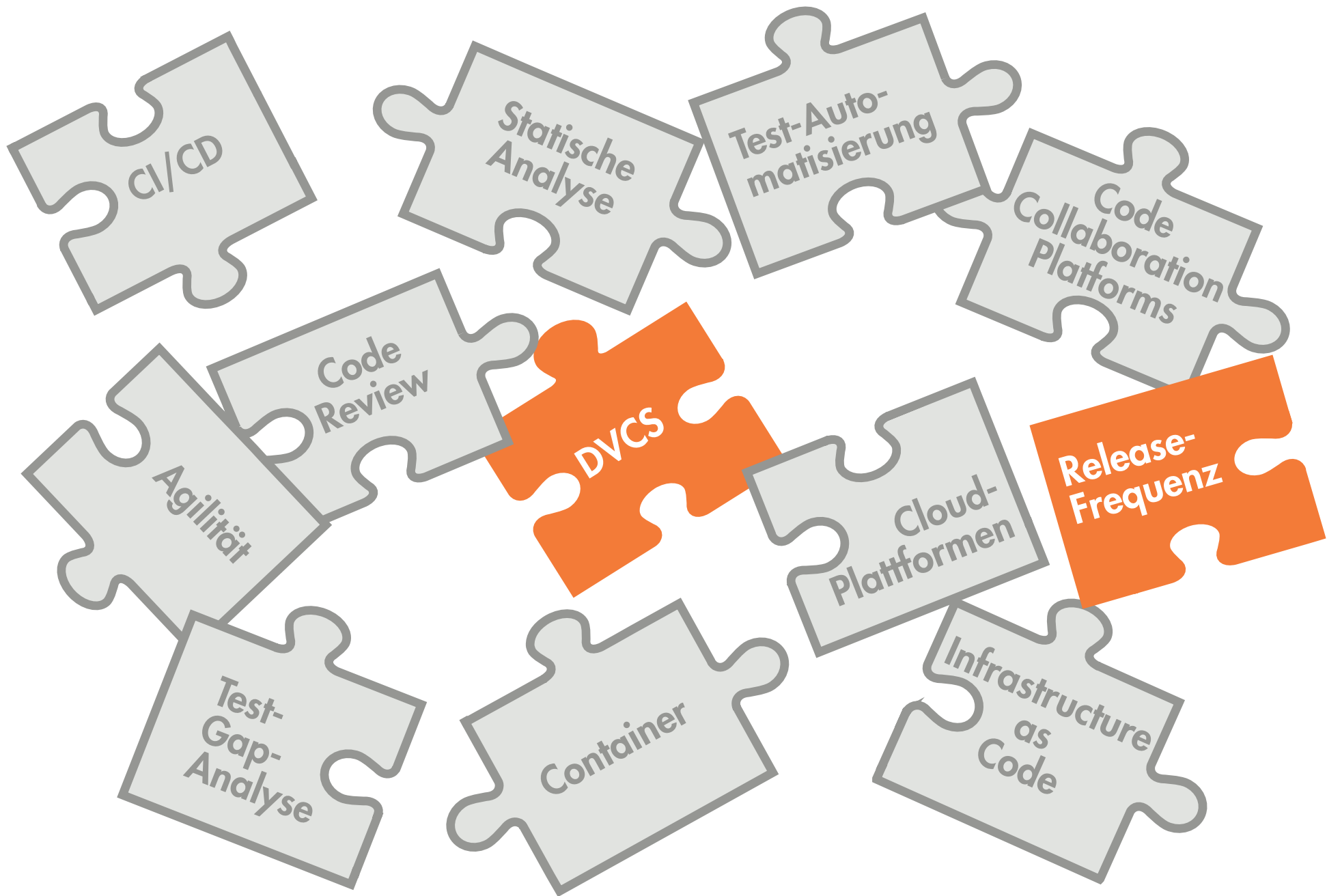

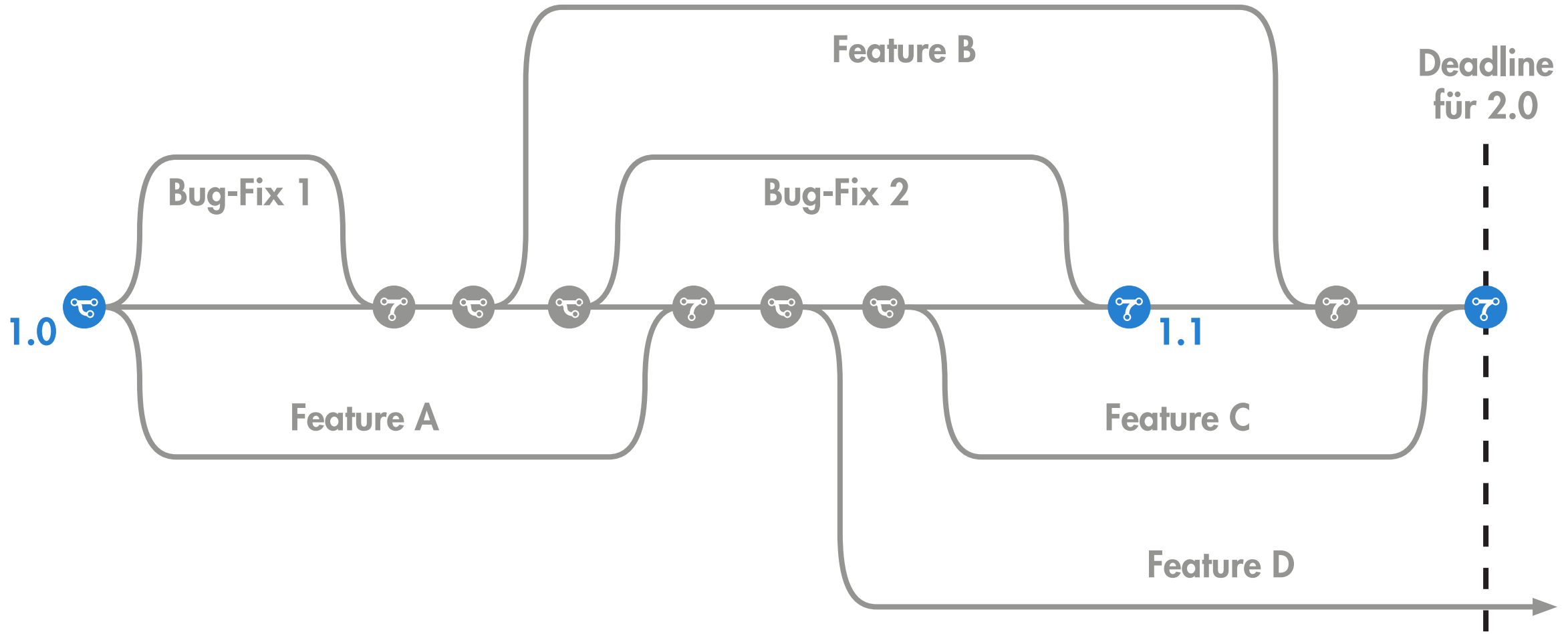
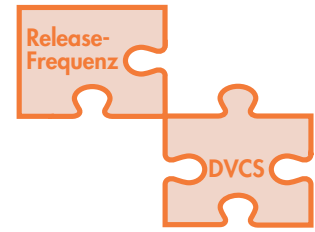

1.0

Bug-Fix 1

Feature A

Bug-Fix 2

Feature B

Feature C

1.1

Feature D

Deadline für 2.0

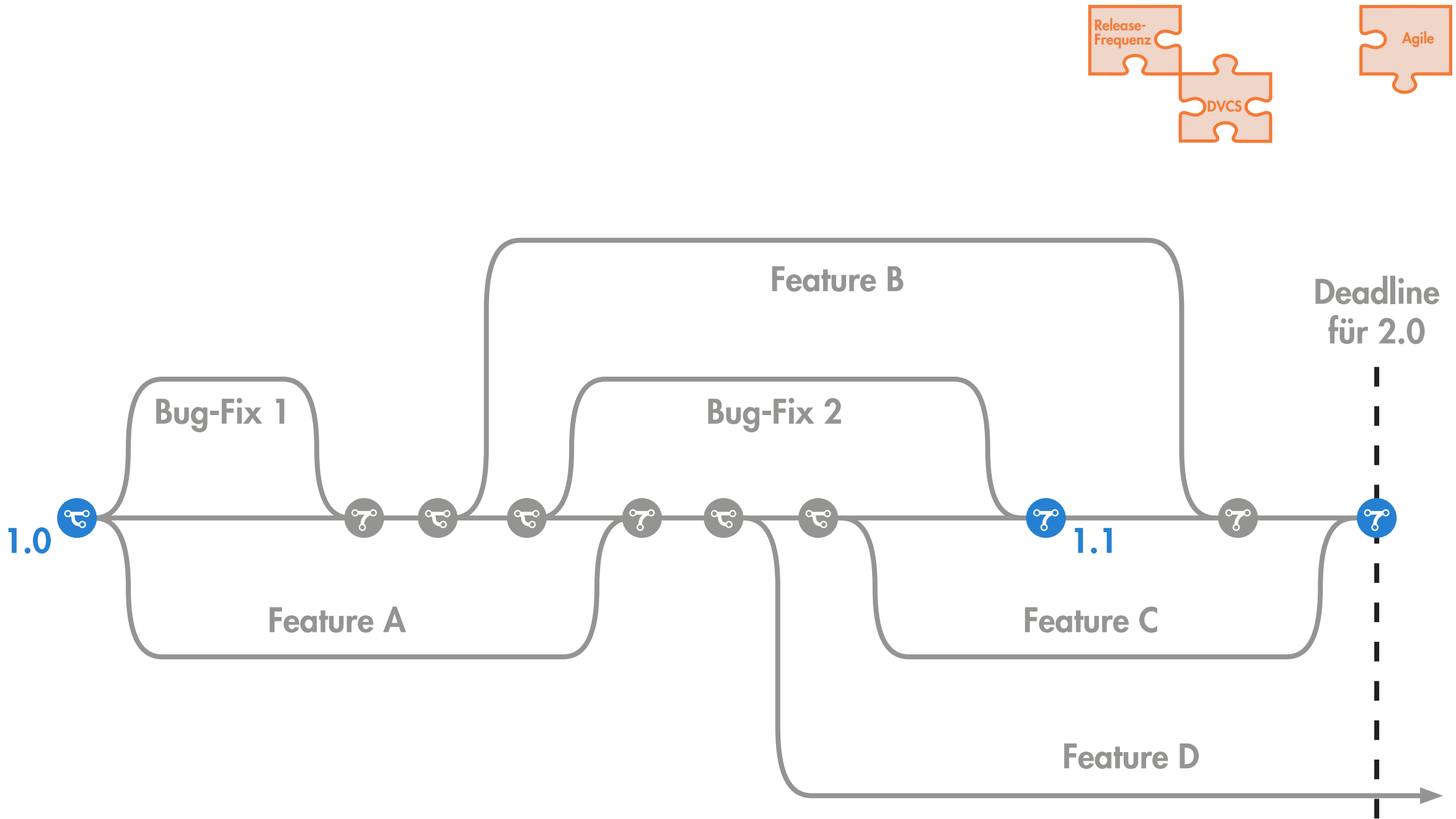

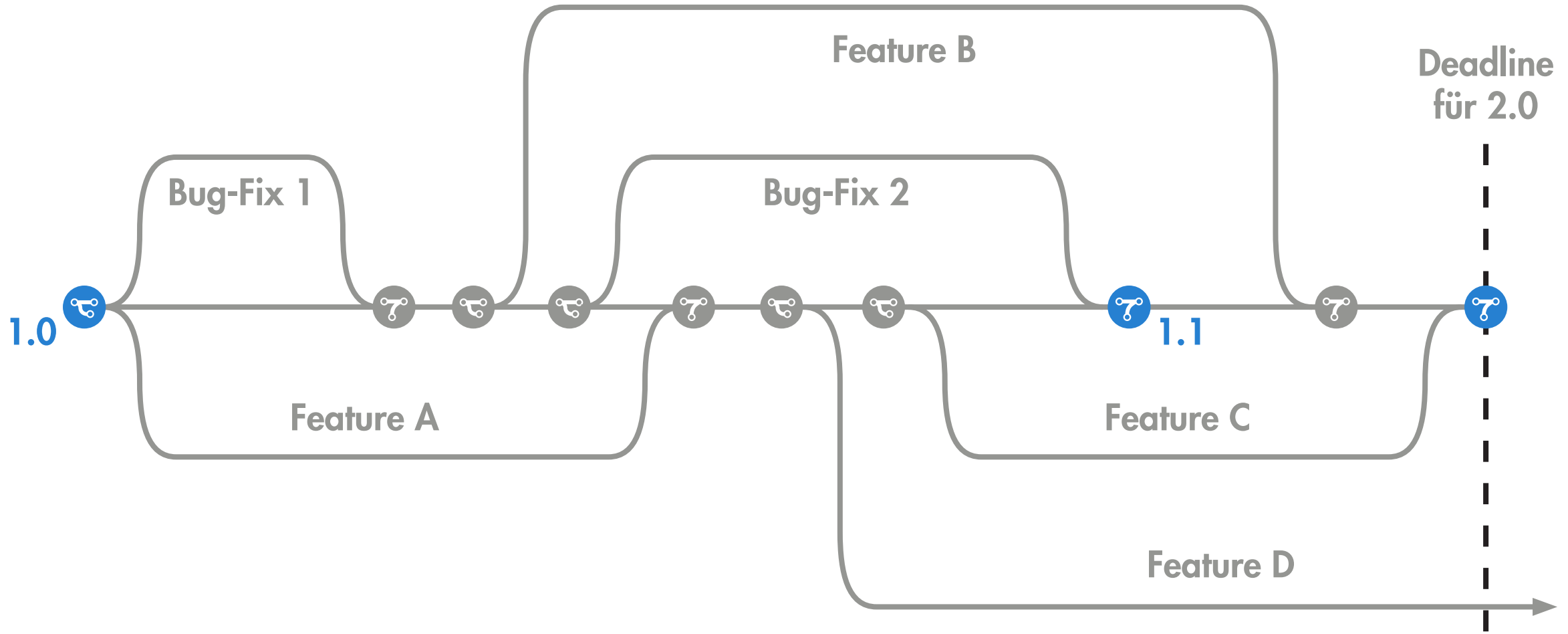
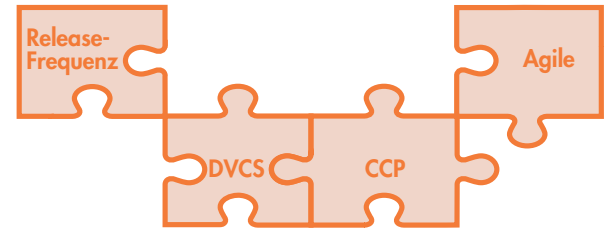

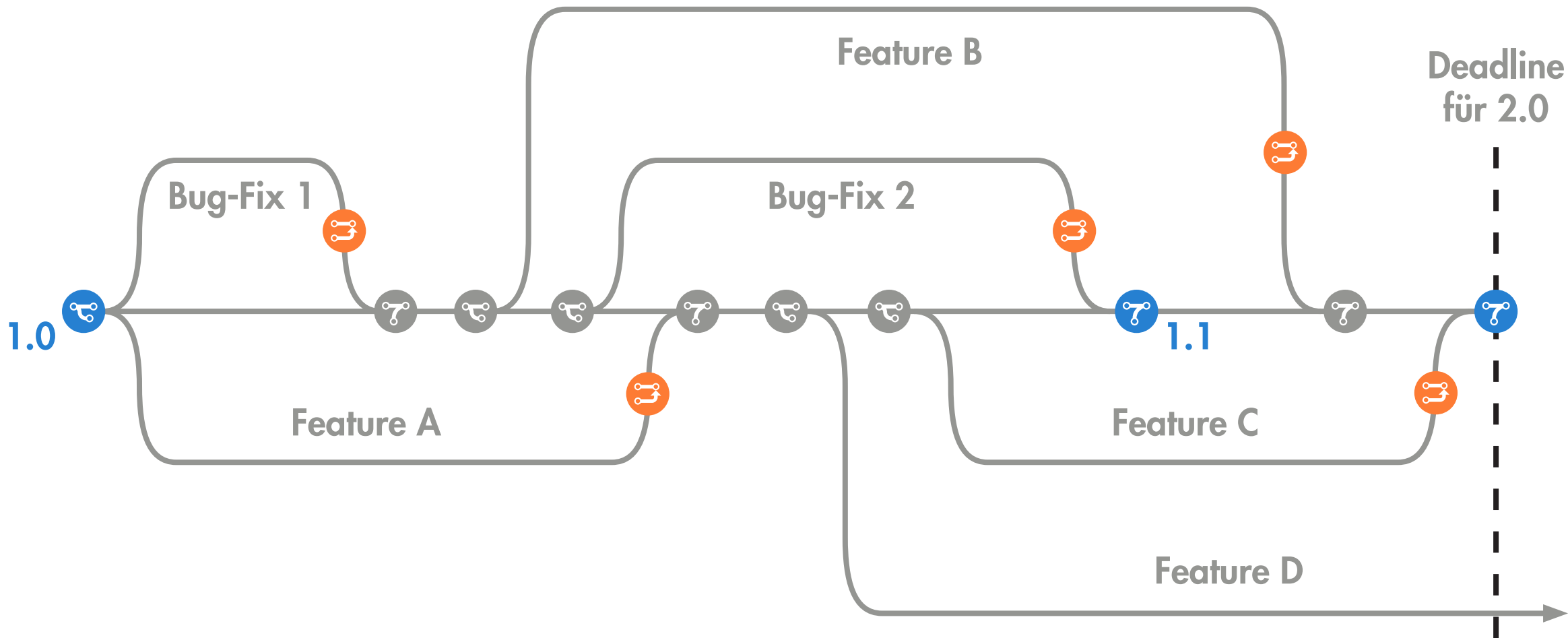
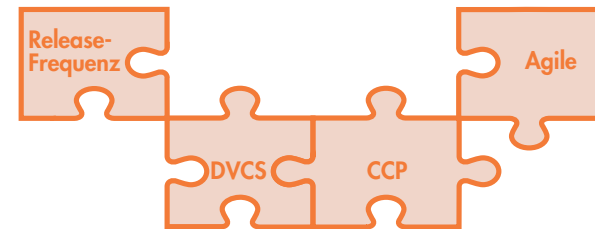

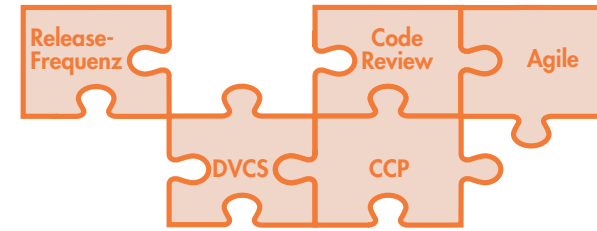



Discussion 1 Commits 2 Pipelines 2 Changes 1 Show all activity 1/1 thread resolved

 **Andreas Sewe** @sewe started a thread on an old version of the diff 4 months ago Resolved by Lars Heinemann 4 months ago [Toggle thread](#)

 **engine/org.conqat.engine.index/src/org/conqat/engine/index/repository/RepositoryContentUpdaterBase.java**

```

293 293      List<BasicTokenElementInfo> tokenElements = tokenElementIndex.getValues(paths);
294 294      for (int i = 0; i < paths.size(); i++) {
295 295          String path = paths.get(i);
296 -         RepositoryChangeInfo changeInfo = changeSet.getChangeInfo(path);
297 -         ERepositoryChangeType changeType = patchChangeType(changeInfo,
           tokenElements.get(i));
298 -         if (changeType != null) {
299 -             result.add(new RepositoryChangeEntry(path,
           requiredNode.getRevision().getRevision(), changeType,
300 -             commit, changeInfo.getOriginPath(),
           changeInfo.getOriginCommit()));
301 -         }
296 +         BasicTokenElementInfo element = tokenElements.get(i);
297 +         addChangeEntry(requiredNode, result, changeSet, path, element);

```

 **Andreas Sewe** @sewe · 4 months ago Maintainer ✓ 😊 ⋮

I would re-order the message signature. ATM, it's hard to tell which parameter the change entry is added to. If you have `result` first, as in `result.add(...)` things become clearer.

Alternatively, let the extracted method return `Optional<RepositoryChangeEntry>` and do the `add` here.

```
computeChangeEntry(requiredNode, changeSet, path, element).ifPresent(result::add);
```

 **Lars Heinemann** @heinemann changed this line in version 2 of the diff 4 months ago

 Unresolve thread

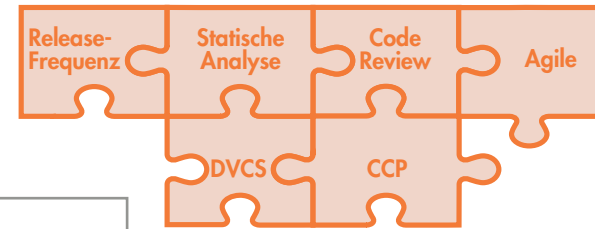

PR #4

Open nkxater wants to merge 22 commits into master from firstBranch

Conversation 0 Commits 22 Checks 1 Files changed 3

Changes from all commits ▾ File filter... ▾ Jump to... ▾ ⚙

▼ 4 jabref/JabRefGUI.java

@@ -35,7 +35,7 @@

```
35
36 public class JabRefGUI {
37
38 - private static final Logger LOGGER = LoggerFactory.getLogger(JabRefGUI.class);
```

```
35
36 public class JabRefGUI {
37
38 + public static final Logger LOGGER = LoggerFactory.getLogger(JabRefGUI.class);
```

Check warning on line 38 in jabref/JabRefGUI.java
 Teamscale App / Teamscale Findings
jabref/JabRefGUI.java#L38
Interface comment missing

▼ 2 jabref/logic/bibtex/BibEntryWriter.java

@@ -163,7 +163,7 @@ private void writeField(BibEntry entry, Writer out, String name, int indentation

```
163 try {
164     out.write(fieldFormatter.format(field.get(), name));
165     out.write(', ' + OS.NEWLINE);
166 - } catch (InvalidFieldValueException ex) {
167     throw new IOException("Error in field '" + name + "': " + ex.getMessage(), ex);
168 }
```

```
163 try {
164     out.write(fieldFormatter.format(field.get(), name));
165     out.write(', ' + OS.NEWLINE);
166 + } catch (Exception ex) {
167     throw new IOException("Error in field '" + name + "': " + ex.getMessage(), ex);
168 }
```

Check failure on line 168 in jabref/logic/bibtex/BibEntryWriter.java
 Teamscale App / Teamscale Findings
jabref/logic/bibtex/BibEntryWriter.java#L166-L168
Catch clause catches generic exception `Exception`

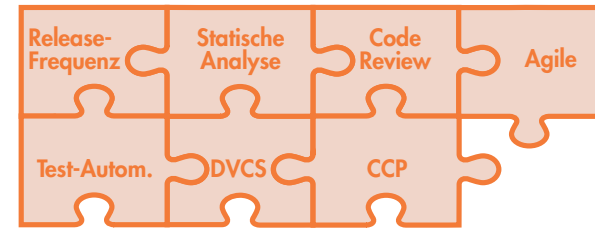

Cr/20002 new report template

Edited 9 hours ago by build



Request to merge cr/20002_new_report_t... **into** teamscale/v5.4.x
The source branch is 31 commits behind the target branch

Open in Web IDE

Check out branch



Pipeline #89447 failed for 040f1ce9 on cr/20002_new_report_t...



Test summary contained 5 failed test results out of 4318 total tests

Expand



Merge



Delete source branch



Squash commits [?](#)



8 commits and **1 merge commit** will be added to teamscale/v5.4.x. [Modify merge commit](#)

You can merge this merge request manually using the [command line](#)

Cr/20002 new report template

Edited 9 hours ago by build



Request to merge cr/20002_new_report_t... **into** teamscale/v5.4.x
The source branch is 31 commits behind the target branch

Open in Web IDE

Check out branch



Pipeline #89447 failed for 040f1ce9 on cr/20002_new_report_t...



Test summary contained 5 failed test results out of 4318 total tests



integration-tests found no changed test results out of 2040 total tests



system-tests found no changed test results out of 193 total tests



ui-tests found 5 failed test results out of 29 total tests



New IssueDetailTest.testCompareLinks



New deleteArchitectureUpload()



New ProjectActivityChartTest.testProjectActivityChartPage



New testDuplicateSlides()



New createReportWithArchitectureAndBaselineAndHead()



unit-tests found no changed test results out of 1919 total tests



js-tests found no changed test results out of 137 total tests



- ui-tests
- dotnet-tests
- integration-tests
- js-tests
- system-tests
- ui-tests-common-lang

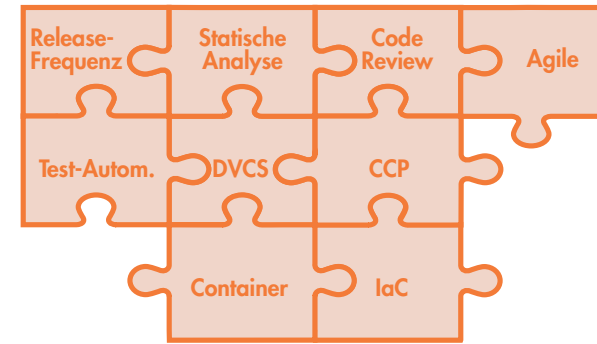

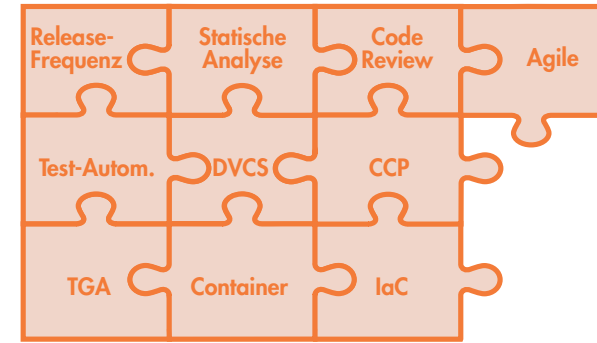

Done Issue **TS-14733 - Remove Dataflow blocks**

Last update: Aug 24 2018 09:32

Creator:  (on Apr 06 2018 19:44)

Assignee: 

Project	Type	Priority	Resolution	Fix Version
TS	Maintenance	Normal	Green	Teamscale 4.5
Component	Labels	Affected Version	Customer	Customer Issue
Backend	Performance			
Epic Name	Freshdesk URL	Merge Request		
		https://git.cqse.eu/cqse/teamscale/3621		

Aug 15 2018 12:37-Now | Test Gap: 22%

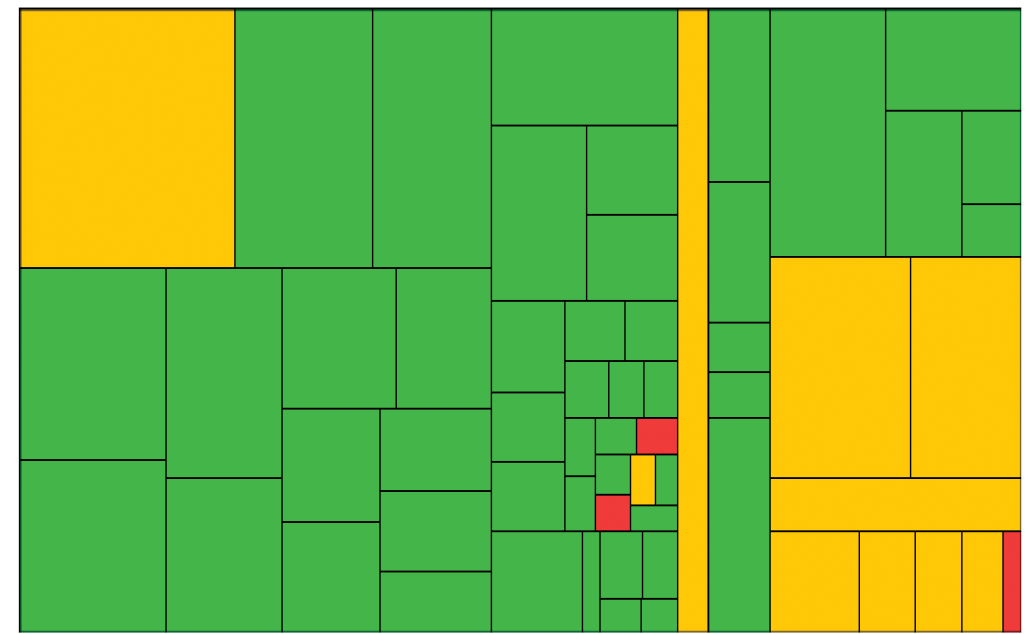

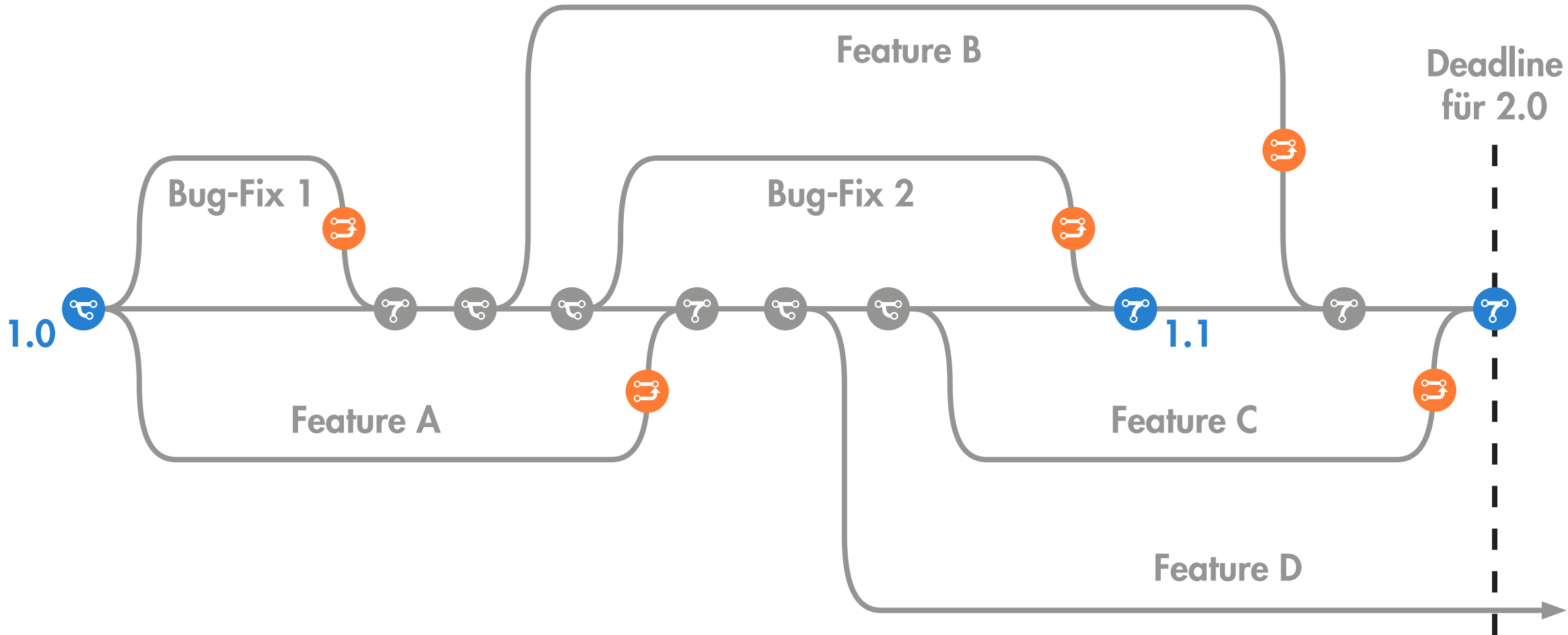
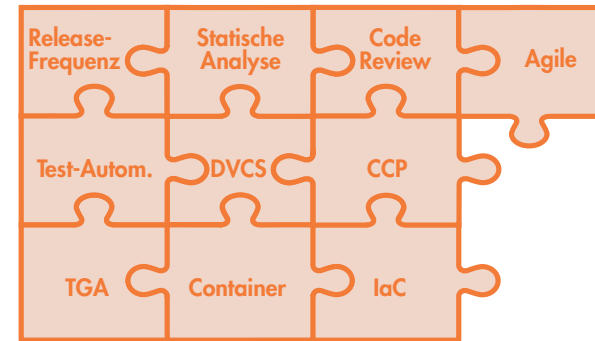

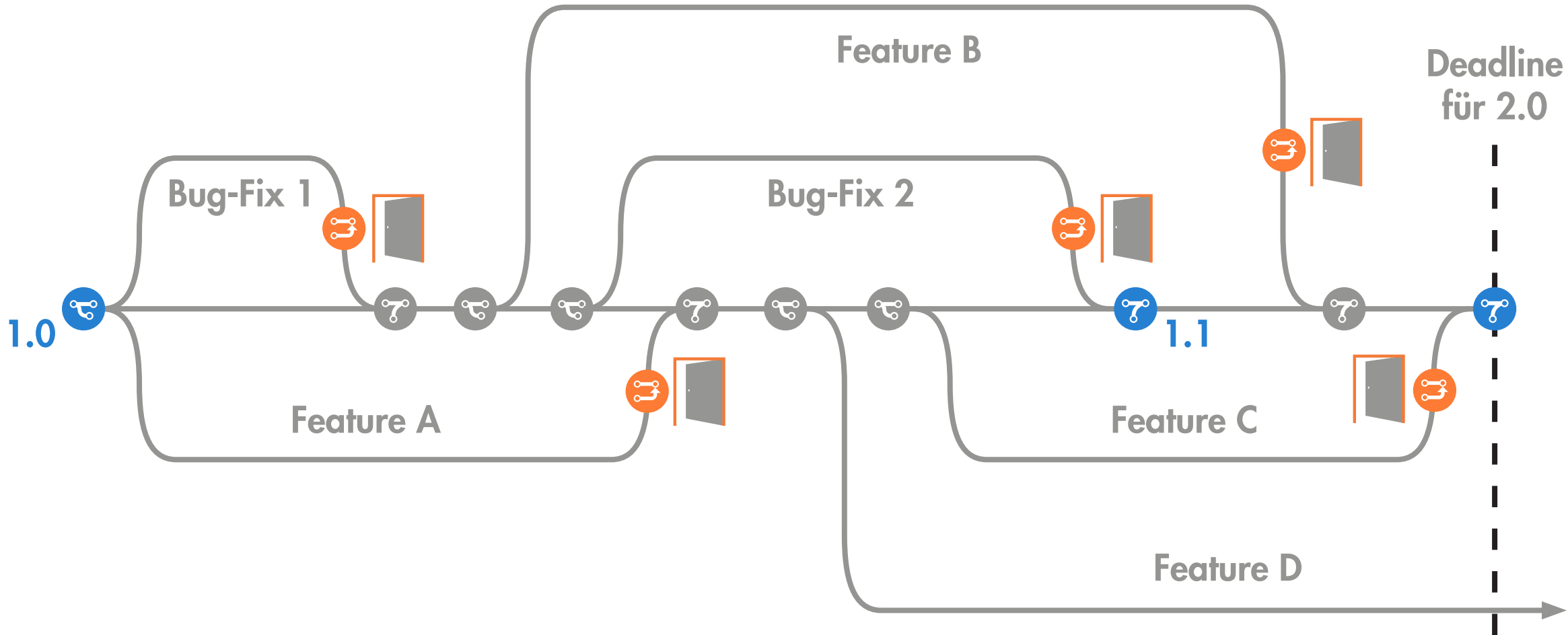
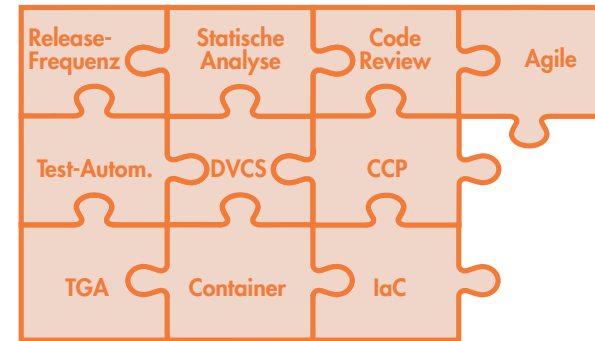

- ✔ Schnell
- ✔ Spezifisch
- ✔ Explizit

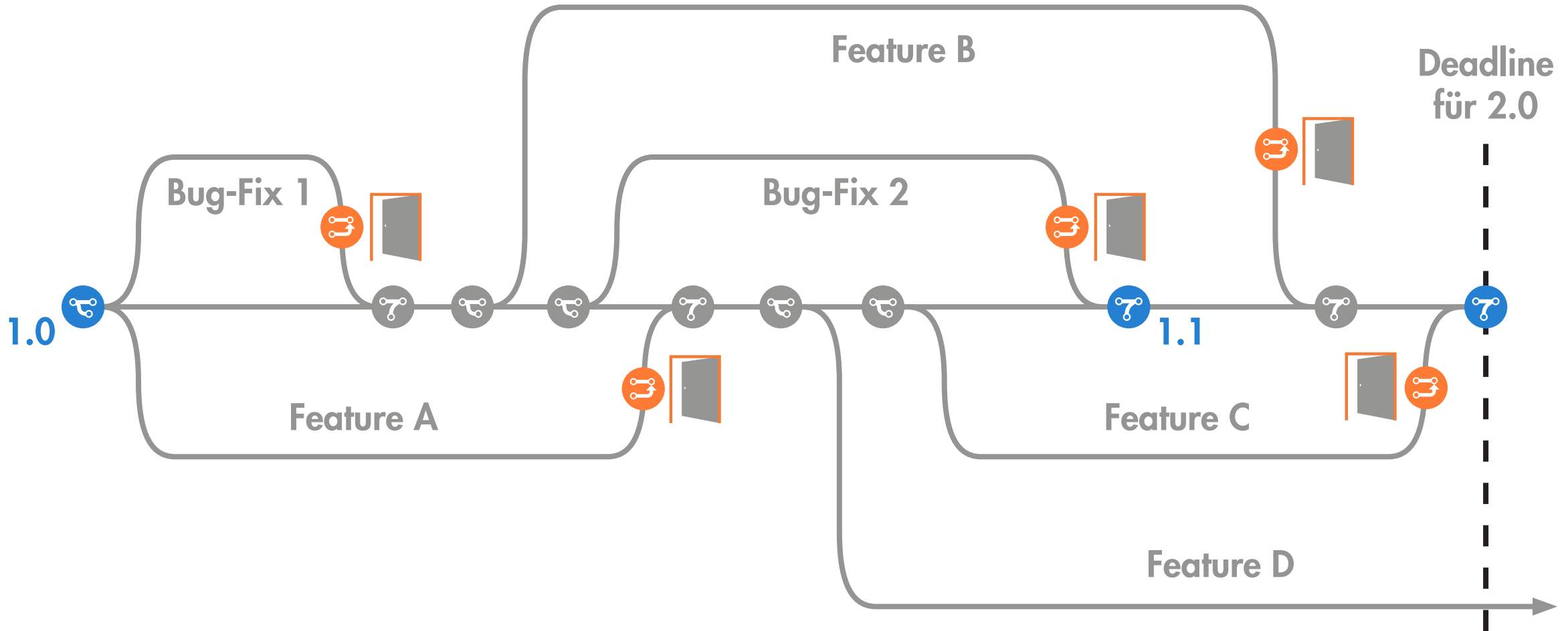
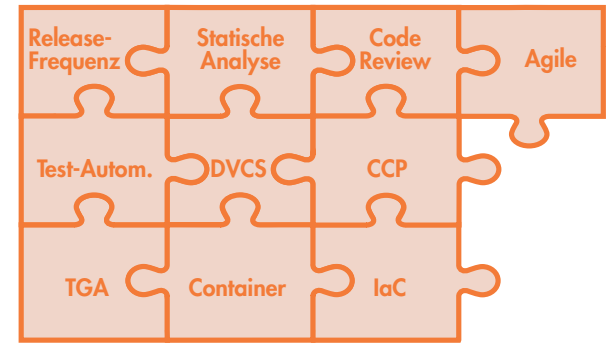

? Schnell

✓ Spezifisch

✓ Explizit

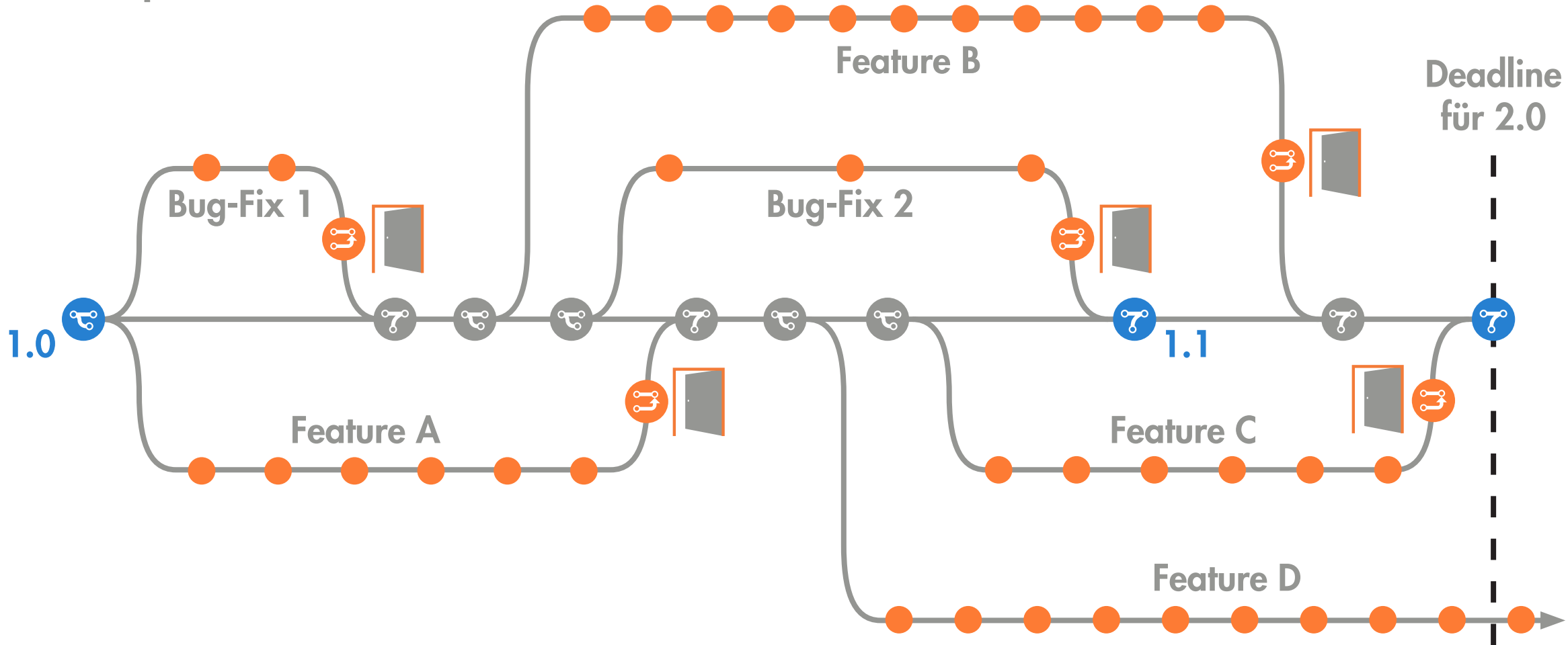
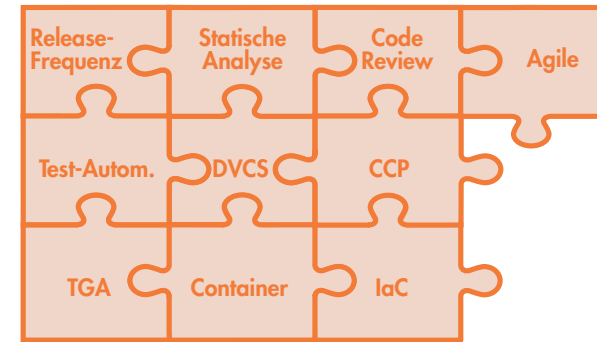

- ✔ Schnell
- ✔ Spezifisch
- ✔ Explizit

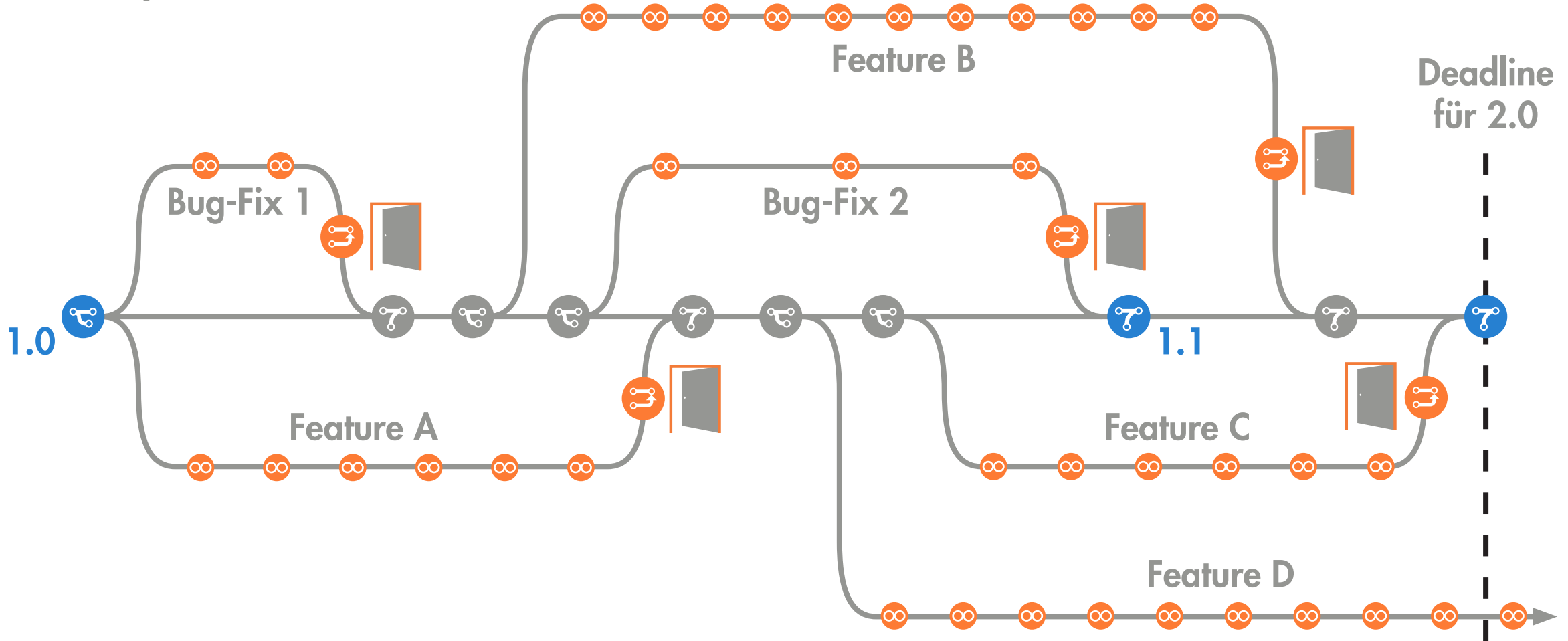
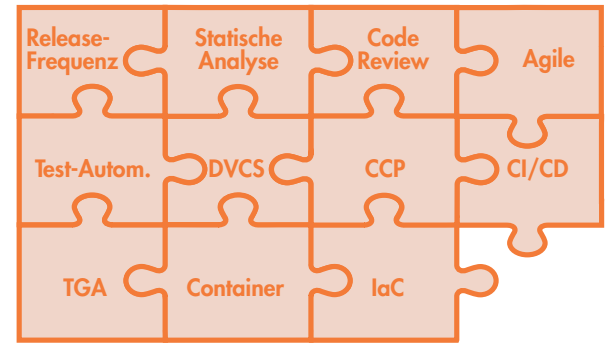

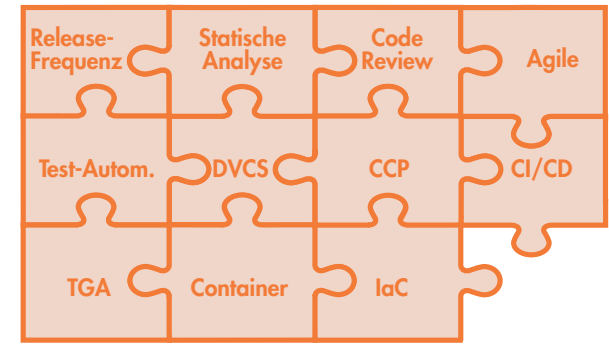
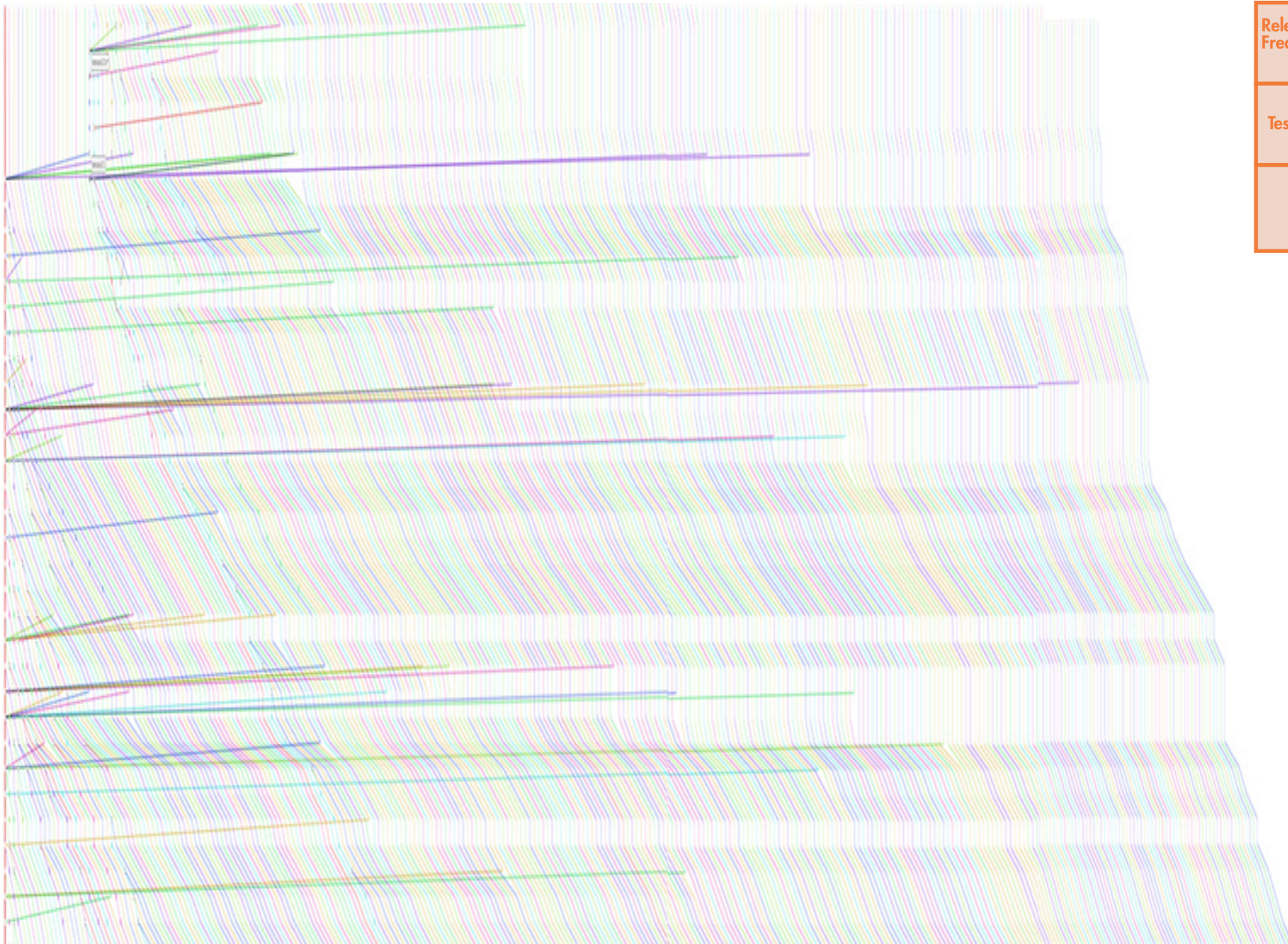

LOC

1.073.401

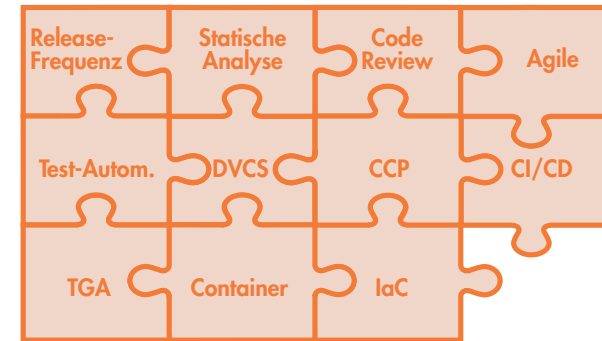

LOC

1.073.401

Entwickler

20

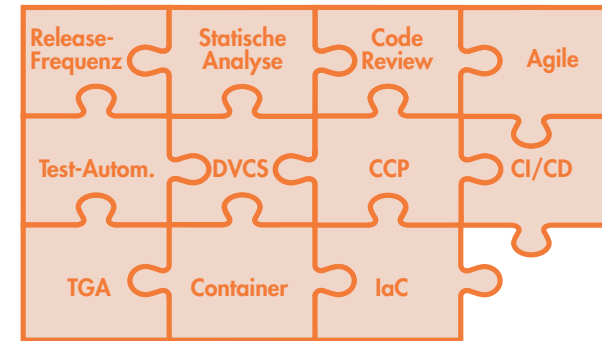

LOC 1.073.401

Entwickler 20

Offene Merge Requests 227

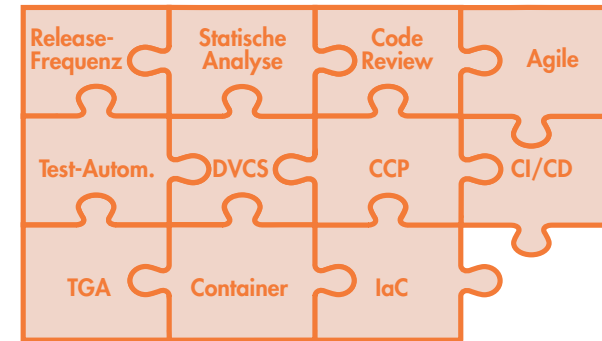

# LOC	1.073.401
# Entwickler	20
# Offene Merge Requests	227
# Automatisierte Tests	8.011

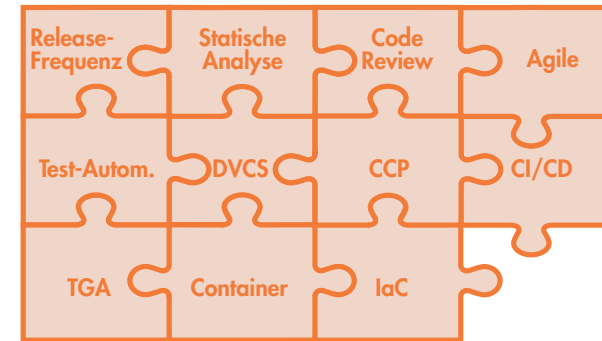

# LOC	1.073.401
# Entwickler	20
# Offene Merge Requests	227
# Automatisierte Tests	8.011
Testausführungsdauer	6.098 s

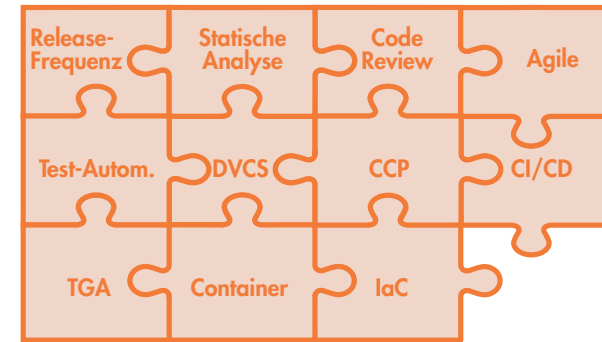

# LOC	1.073.401
# Entwickler	20
# Offene Merge Requests	227
# Automatisierte Tests	8.011
Testausführungsdauer	6.098 s
# Commits/h	2,2

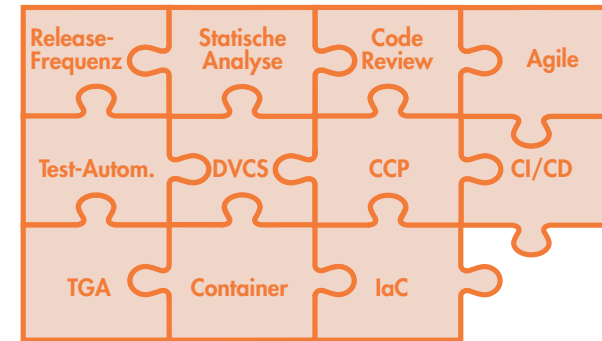

# LOC	1.073.401
# Entwickler	20
# Offene Merge Requests	227
# Automatisierte Tests	8.011
Testausführungsdauer	6.098 s
# Commits/h	2,2
# Build Jobs/h	25

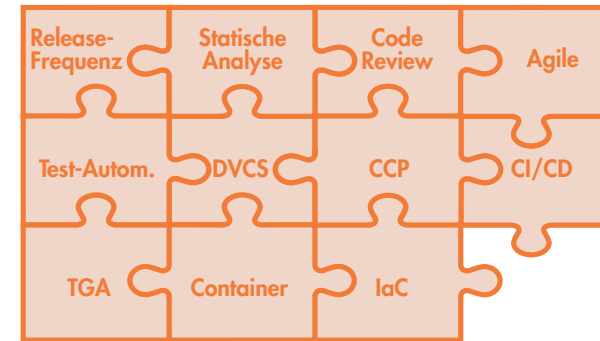

# LOC	1.073.401
# Entwickler	20
# Offene Merge Requests	227
# Automatisierte Tests	8.011
Testausführungsdauer	6.098 s
# Commits/h	2,2
# Build Jobs/h	25
# Build Server	7

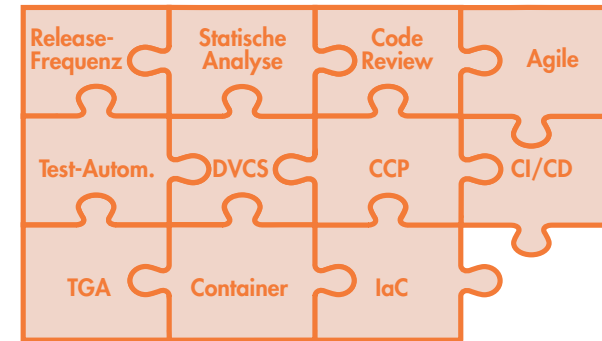

LOC 1.073.401

Entwickler 20

Offene Merge Requests 227

Automatisierte Tests 8.011

Testausführungsdauer 6.098 s

Commits/h 2,2

Build Jobs/h 25

Build Server 7

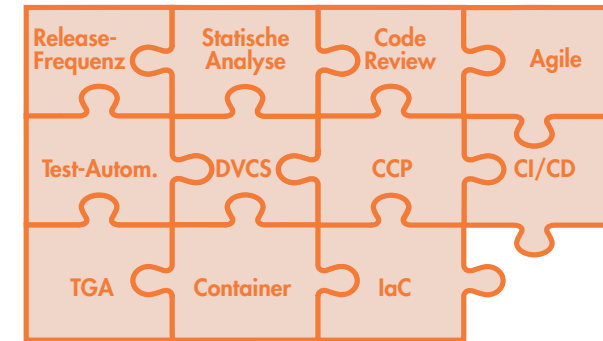

Test-Impact-Analyse (TIA)

LOC 1.073.401

Entwickler 20

Offene Merge Requests 227

Automatisierte Tests 8.011

Testausführungsdauer 6.098 s

Commits/h 2,2

Build Jobs/h 25

Build Server 7

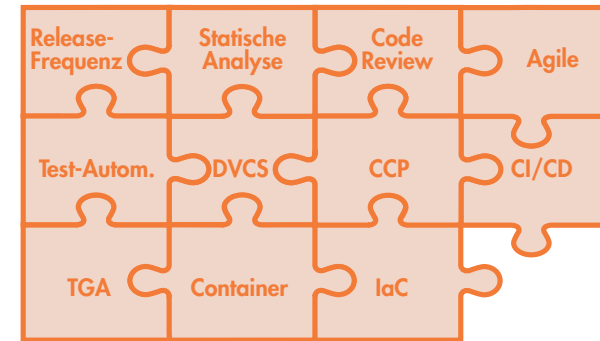

LOC 1.073.401

Entwickler 20

Offene Merge Requests 227

Automatisierte Tests 8.011

Testausführungsdauer 6.098 s

Commits/h 2,2

Build Jobs/h 25

Build Server 7

Max

26

257

100

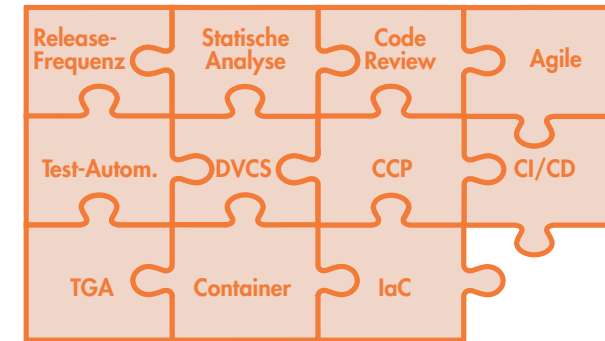

# LOC	1.073.401	
# Entwickler	20	
# Offene Merge Requests	227	
# Automatisierte Tests	8.011	
Testausführungsdauer	6.098 s	Max
# Commits/h	2,2	26
# Build Jobs/h	25	257
# Build Server	7	100

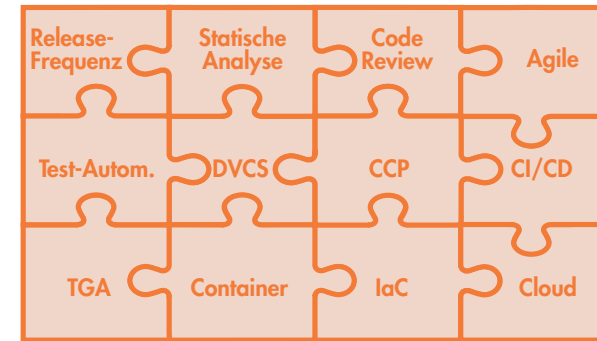

LOC 1.073.401

Entwickler 20

Offene Merge Requests 227

Automatisierte Tests 8.011

Testausführungsdauer 6.098 s

Commits/h 2,2

Build Jobs/h 25

Build Server 7

Kosten/Monat 600 €

Max

26

257

100

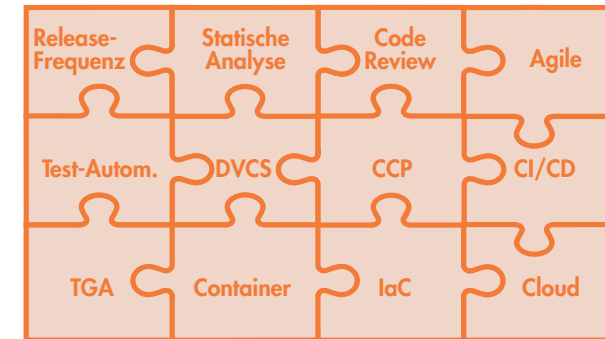

**Release-
Frequenz**

**Statische
Analyse**

**Code
Review**

Agilität

**Test-Auto-
matisierung**

DVCS

**Code
Collaboration
Platforms**

CI/CD

**Test-
Gap-
Analyse**

Container

**Infrastructure
as
Code**

**Cloud-
Plattformen**

Release-
Frequenz

Statische
Analyse

Code
Review

Agilität

Test-Auto-
matisierung

DVCS

Code
Collaboration
Platforms

CI/CD

Test-
Gap-
Analyse

Container

Infrastructure
as
Code

Cloud-
Plattformen



Kontakt - Ich freue mich auf Fragen und Diskussionen!



Dr. Sven Amann · amann@cqse.eu · +49 172 1860063

CQSE GmbH c/o HUB31
Hilpertstr. 31
64295 Darmstadt

Im Anschluss:

cqse.eu/entwicklertag2021



CQSE